

断面図 A-A

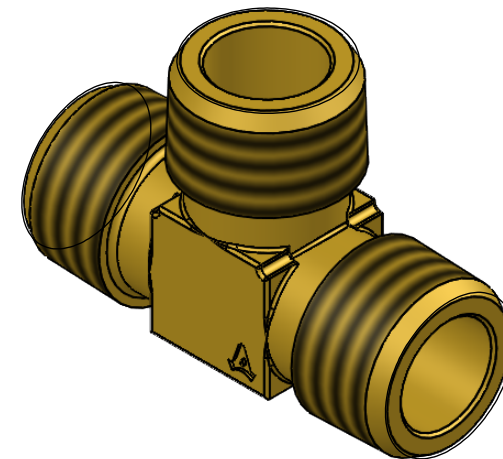
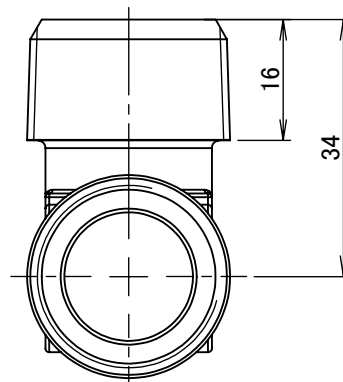
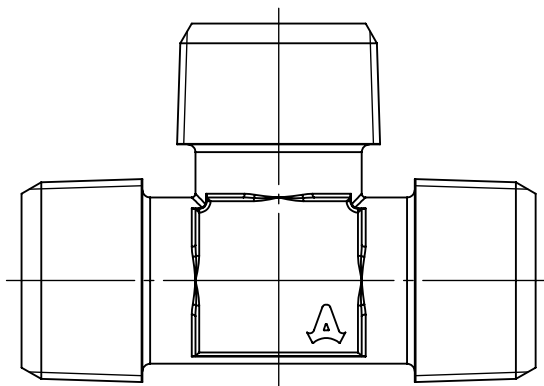

		第3角法	単位 mm	尺度 1:1	日付 2020/12/16
承認	水田	検図	水田	材質	C3771B(cd75ppm以下)
設計	水田	製図	恵良	備考	
				品名	外ネジチーズ TM-1666R
				図番	5R-TM1666