

断面図 A-A

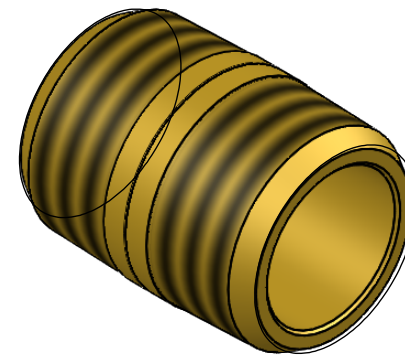
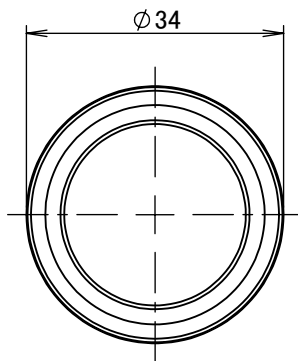
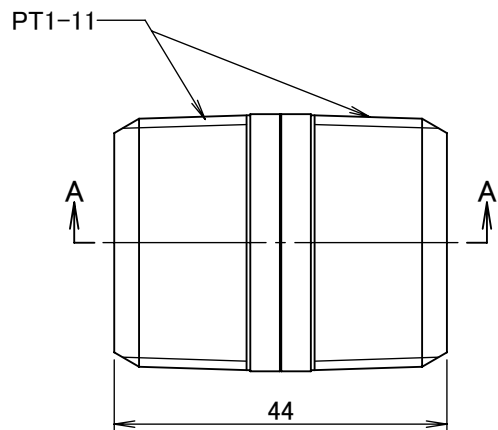

		第3角法	単位 mm	尺度 1:1	日付 2020/06/01
承認	水田	検図	水田	材質	C3604B(cd75ppm以下)
設計	水田	製図	水田	備考	
				品名・品番	丸ニップル NI-1088R
				図番	5R-NI1088