

断面図 A-A

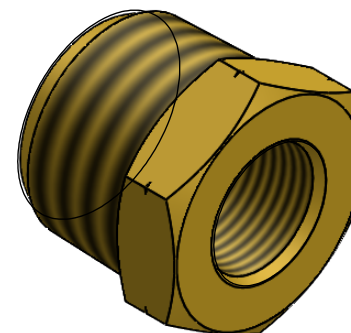
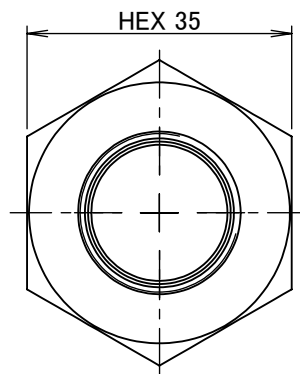
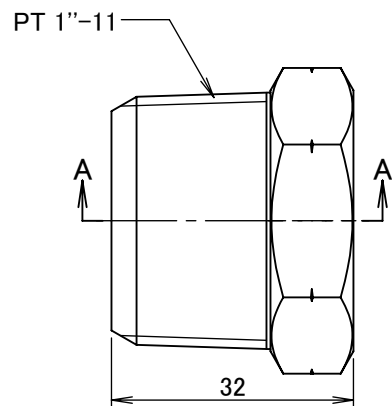

		第3角法	単位 mm	尺度 1:1	日付 2020/06/01
承認	水田	検図	水田	材質 C3604BD(cd75ppm以下)	
設計	水田	製図	恵良	備考	
 ASOH CO.,LTD.			品名・品番 ブッシング NB-1084R		
			図番 5R-NB1084		