

断面図 A-A

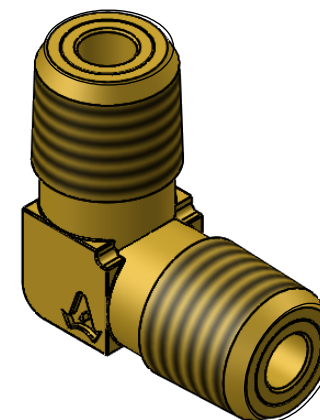
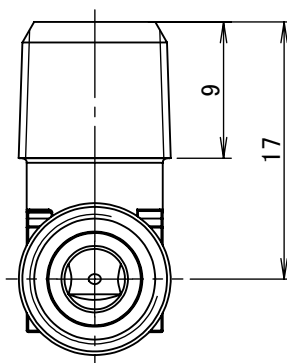
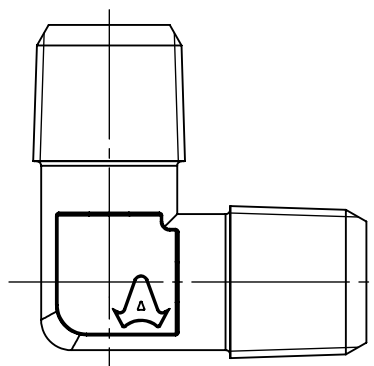

		第3角法	単位 mm	尺度 2:1	日付 2020/12/14
承認	水田	検図	水田	材質	C3771B(cd75ppm以下)
設計	水田	製図	恵良	備考	
				品名	外ネジエルボ LM-1011R
				図番	5R-LM1011
ASOH CO.,LTD.					