

断面図 A-A

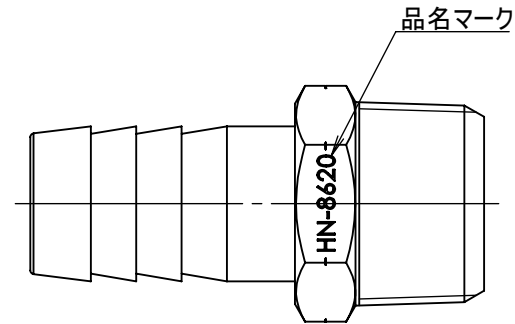
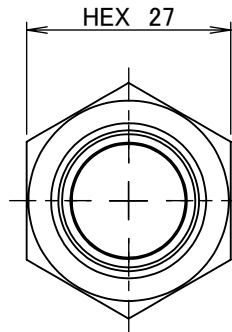
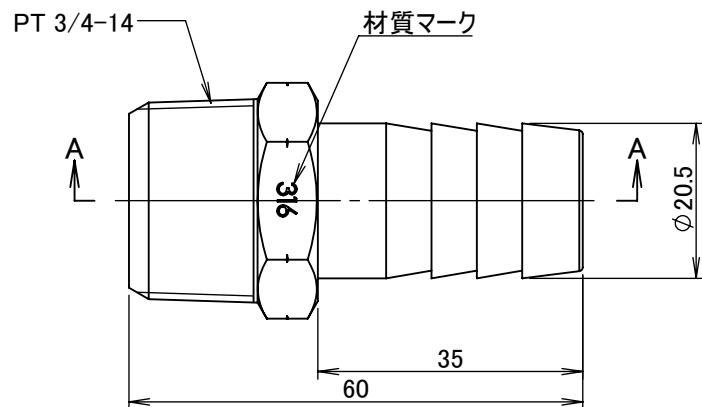
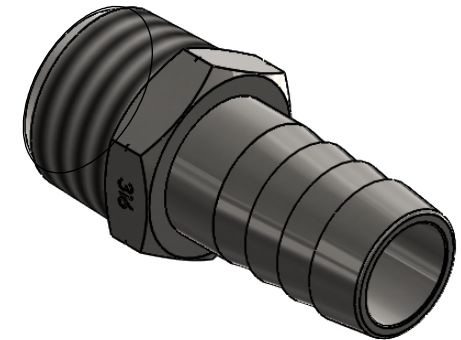

		第3角法	単位 mm	尺度 1:1	日付 2023/05/15
承認 水田	検図 水田	材質 SUS316			
設計 水田	製図 石田	備考			
		品名 エースニップル HN-8620			
		図番 5HN-8620			