

断面図 A-A

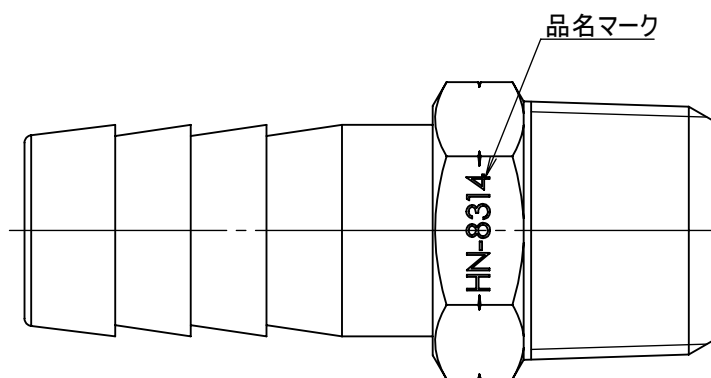
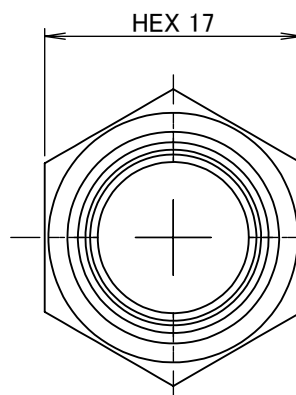
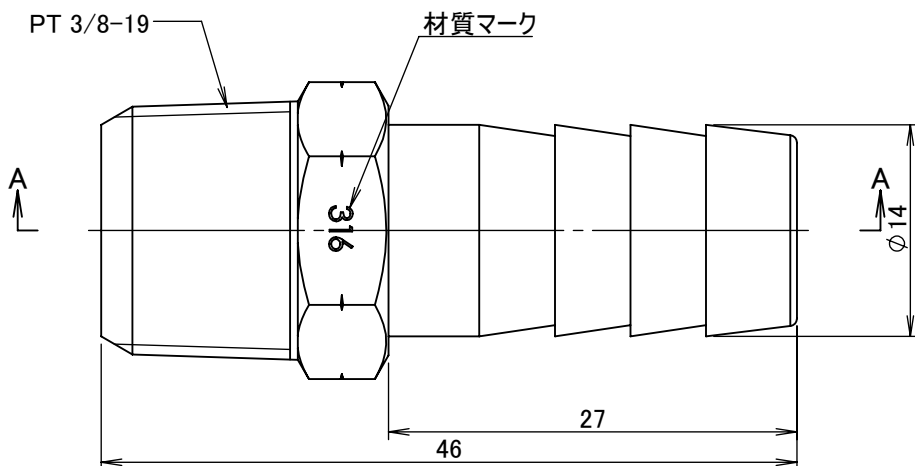

		第3角法	単位 mm	尺度 2:1	日付 2023/05/11
承認	水田	検図	水田	材質	SUS316
設計	水田	製図	石田	備考	
			品名	エースニップル HN-8314	
			図番	5HN-8314	