

断面図 A-A

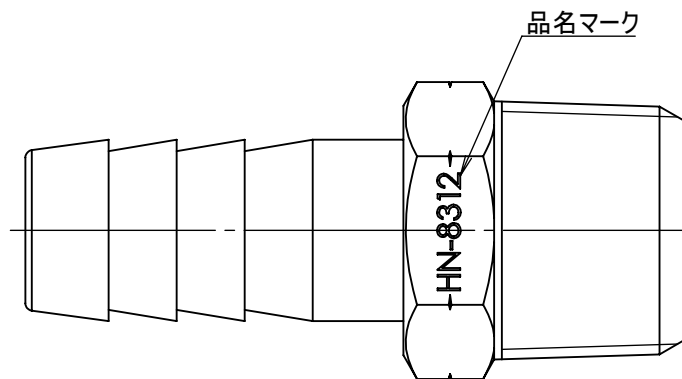
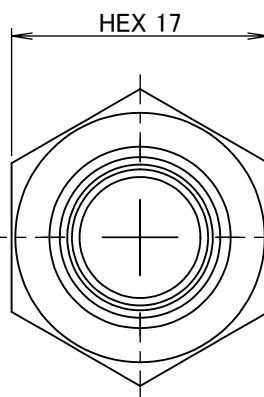
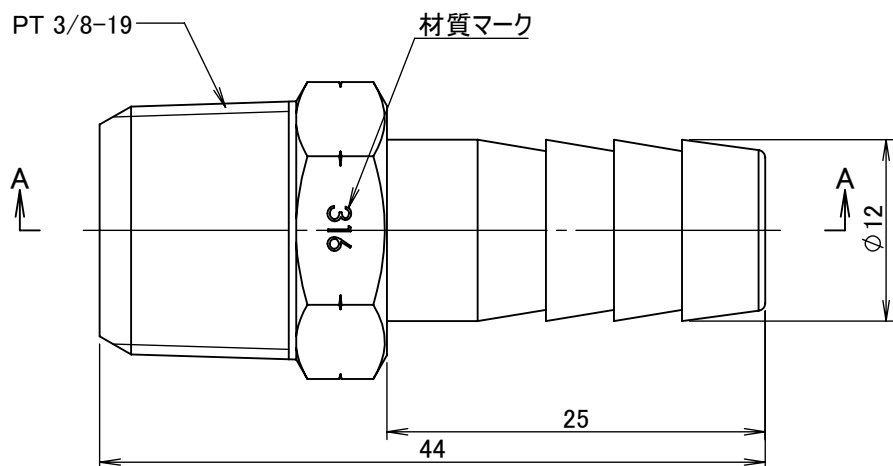

		第3角法	単位 mm	尺度 2:1	日付 2023/05/11
承認 水田	検図 水田	材質 SUS316			
設計 水田	製図 恵良	備考			
		品名 エースニップル HN-8312			
		図番 5HN-8312			