

断面図 A-A

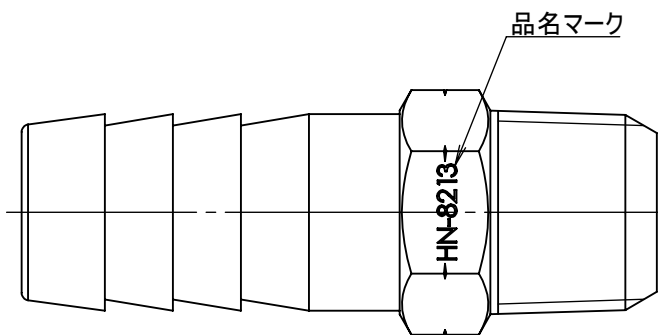
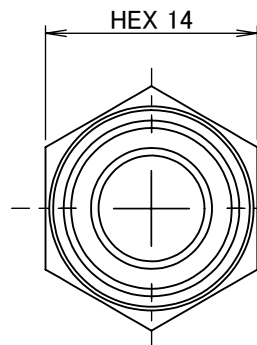
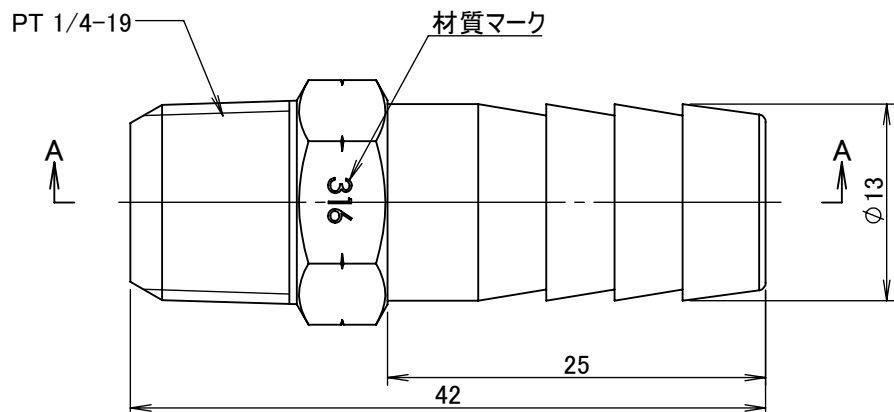

		第3角法	単位 mm	尺度 2:1	日付 2023/05/01
承認 水田	検図 水田	材質	SUS316		
設計 水田	製図 恵良	備考			
		品名	エースニップル HN-8213		
		図番	5HN-8213		