

断面図 A-A

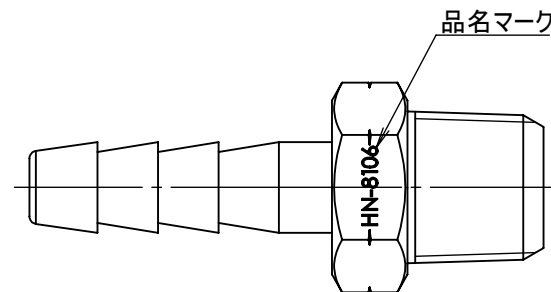
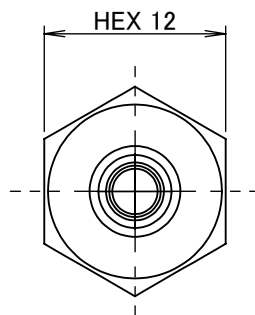
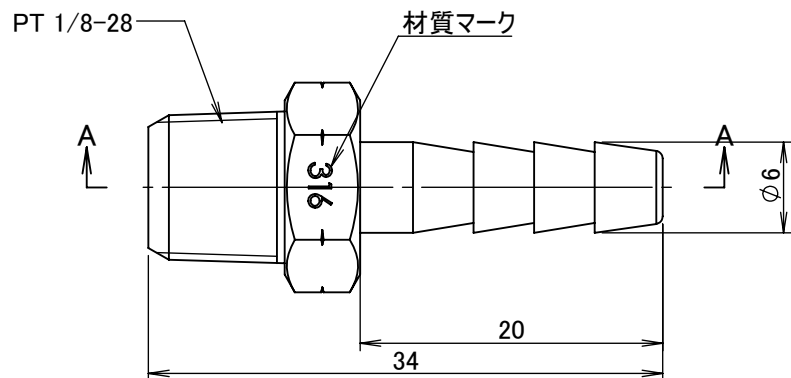
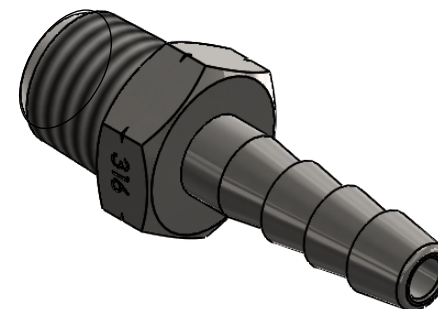

		第3角法	単位 mm	尺度 2:1	日付 2023/04/20
承認 水田	検図 水田	材質		SUS316	
設計 水田	製図 恵良	備考			
 ASOH CO.,LTD.		品名		エースニップル HN-8106	
		図番		5HN-8106	