

断面図 A-A

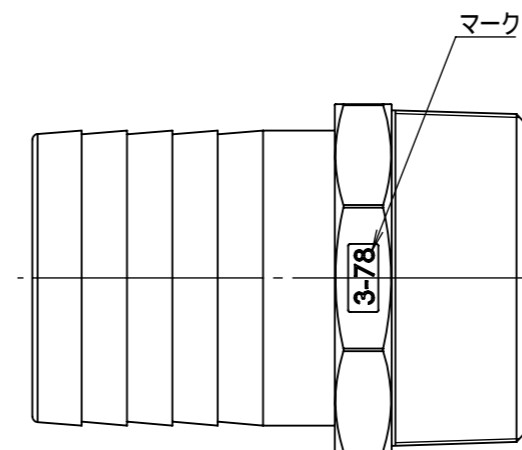
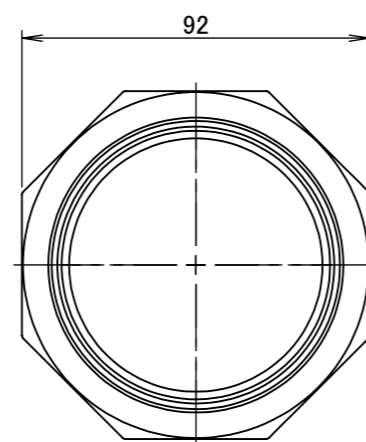
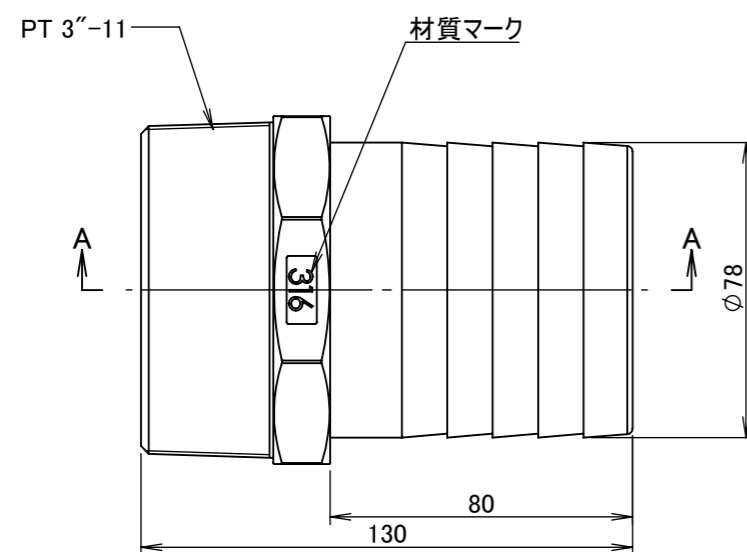
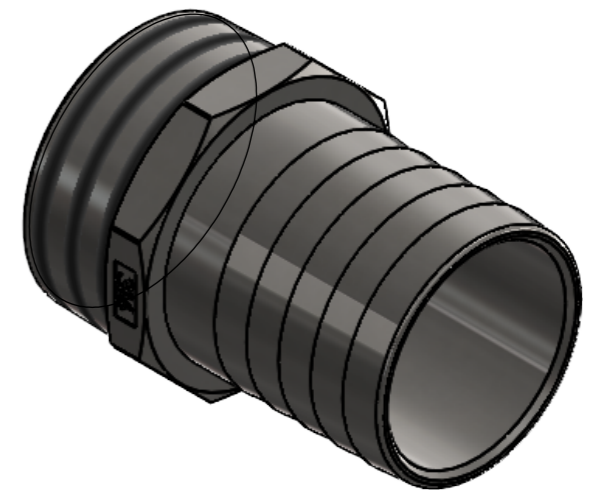

		第3角法	単位 mm	尺度 1:2	日付 2023/08/21
承認	水田	検図	水田	材質	SCS14A
設計	水田	製図	恵良	備考	
				品名	メガニップル HN-8078
				図番	5HN-8078