

断面図 A-A

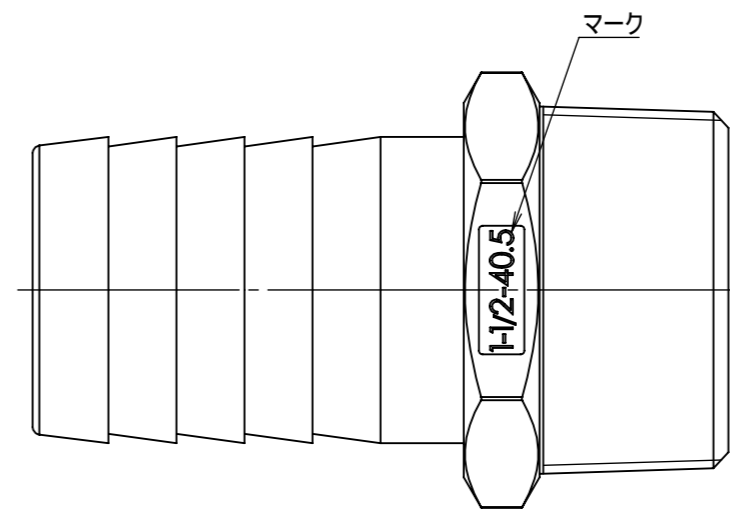
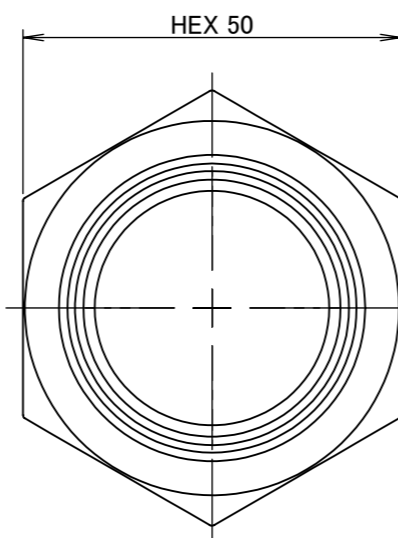
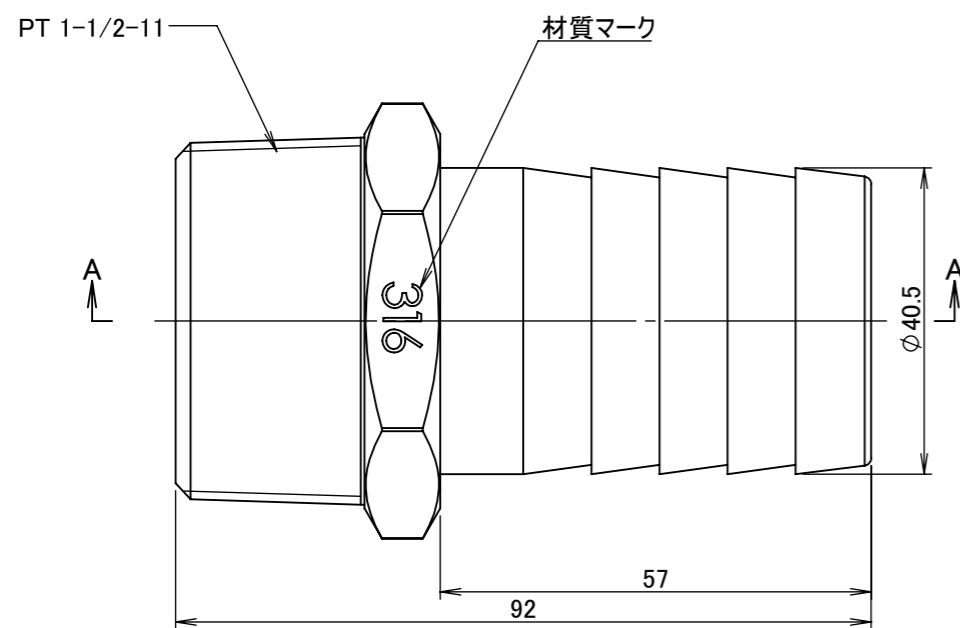
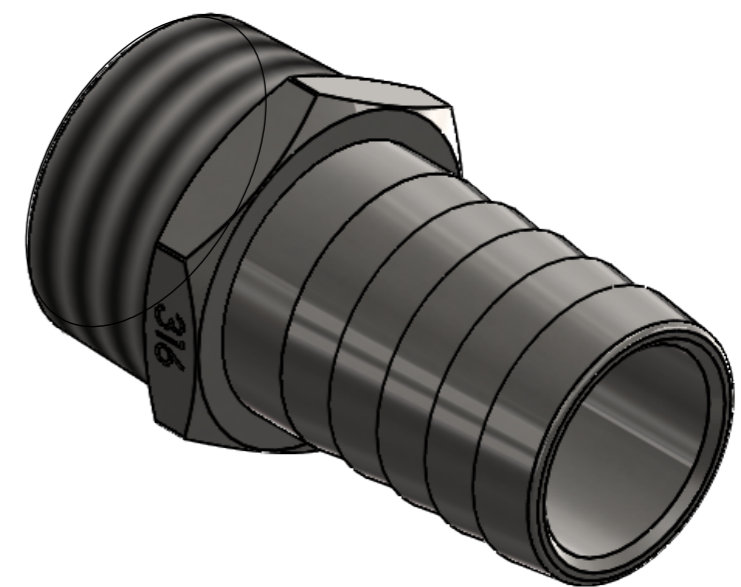

		第3角法	単位 mm	尺度 1:1	日付 2023/05/19
承認	水田	検図	水田	材質	SCS14A
設計	水田	製図	恵良	備考	
				品名	メガニップル HN-8040
				図番	5HN-8040