



Fittings

Hosenipple, Acenipple,
Pipefitting, Screwfitting,

vol.23

Ace Fittings

vol. 23

使用材料

- エースニップル(ステンレスホースニップル)は JIS G4318-98の SUS304SPB 材を使用。
- 黄銅棒は JIS H3250 の C3604BD 材を使用。
- 鍛造材は JIS H3250 の C3771BD 材を使用。
- 黄銅製品による**RoHS**品番号は Cd>75ppm 以下材を使用。

ネジ規格

- 管用平行ネジは JIS B0202 規格。
 - 管用テーパネジは JIS B0203 規格。(但し、有効ネジ長さは、アソー規格による)
 - ユニファイ細目ネジは JIS B0208 規格。
- 各々準拠し寸法許容差は中級及び2級以上です。

銅管継手

- 接続管は銅管(質別は 0、0L、1/2H)を使用してください。
- 管は真円に近い物で外表面は滑らかであり、切断はパイプカッターを使用し内、外面のバリ、カエリは取り除いてください。

● 組付作業要領

リング型ジョイント……管をリングナットの穴へ止まる位置まで差し込み、ナットを手で締め付けた後スパナで1/2~1回転するまで徐々に締め付けてください。

フレア型ジョイント…ナットを管に差し込み、管端を45°用フレアツールにて拡管し、本体側へ手で締め付けた後、スパナで1/2~1回転するまで徐々に締め付けてください。

※注意事項

各々のジョイントは金属面同士の接触で適正な面圧にて洩れを止める構造の商品なので接触面の傷、打痕、腐食跡には注意してください。また、過度の締め付けは変形による洩れの発生や残留応力による事後の「応力腐食割れ」を生じる原因になります。

使用条件

- 使用圧力 ホース継手類 3.45MPa以下(35kgf/cm²以下)
 銅管継手類 3.45MPa以下(35kgf/cm²以下)
 ネジ継手類 6.90MPa以下(70kgf/cm²以下)
- 使用温度 -50℃~+150℃
- 流 体 水、空気、油、他材質に悪影響のない物。
- 燃焼ガス類、船用にも使用可能ですが、公的機関の制約のある箇所には使用しないでください。

注意

継手の不適切な選択又は取り扱い、人体やシステムに故障・損傷を与える恐れがあります。システム設計者及びユーザーの責任と権限による判断のもとに、使用されるシステムとの適合性や使用条件を考慮の上、継手を選定し、適切な取り付け、操作及びメンテナンスを行って下さい。



- アソー株式会社は ISO9001、ISO14001の認証を取得し、信頼出来る製品造りと環境に配慮した事業活動を推進しています。

目次

ホース継手

エースニップル (SUS)	1
ホースニップル	3
接手	5
水口	5
アングル型ホースニップル	6
ホースジョイント用竹の子・袋ナット	6
ホースジョイント	7

リング式継手

リングジョイント	9
リングエルボ	12
リングチーズ	13
リングナット・リング玉	15

フレアー式継手

フレアージョイント	16
フレアーエルボ	18
フレアーチーズ	19
フレアーナット	20

ネジ継手

プラグ・キャップ	21
ニップル	22
プッシング	23
ソケット	23
変換内外ソケット(黄銅)	24
エルボ	25
チーズ	26
クロス	27
変換内外ソケット(SUS304)	28

エースニップル

SUS304

一部SCS13もあります。

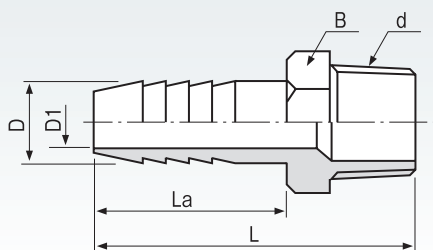
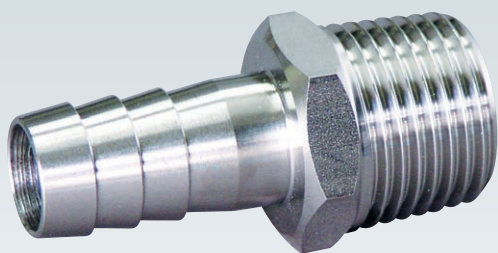

品番	寸法 (mm)					
	d	φD	φD1	B	La	L
HN-7105	PT1/8	5	3	12	20	36
HN-7106	PT1/8	6	3	12	20	36
HN-7165	PT1/8	6.5	3	12	20	36
HN-7107	PT1/8	7	4	12	20	36
HN-7108	PT1/8	8	5	12	20	36
HN-7109	PT1/8	9	5.5	12	20	36
HN-7110	PT1/8	10.5	6	12	20	36
HN-7206	PT1/4	6	3	14	24	42
HN-7265	PT1/4	6.5	3	14	24	42
HN-7207	PT1/4	7	4	14	24	42
HN-7208	PT1/4	8	5	14	24	42
HN-7209	PT1/4	9	5	14	24	42
HN-7210	PT1/4	10.5	6	14	24	42
HN-7212	PT1/4	12	8	14	24	42
HN-7213	PT1/4	13	8	14	24	42
HN-7214	PT1/4	14	8	17	24	42
HN-7306	PT3/8	6	3	17	25	44
HN-7365	PT3/8	6.5	3	17	25	44
HN-7307	PT3/8	7	4	17	25	44
HN-7308	PT3/8	8	5	17	25	44
HN-7309	PT3/8	9	6	17	25	44
HN-7310	PT3/8	10.5	6	17	25	44
HN-7312	PT3/8	12	8	17	25	44
HN-7313	PT3/8	13.5	8	17	25	44
HN-7314	PT3/8	14	9	17	25	44
HN-7316	PT3/8	16	11	17	25	44
HN-7406	PT1/2	6	3	22	27	49
HN-7407	PT1/2	7	4	22	27	49
HN-7408	PT1/2	8	5	22	27	49
HN-7409	PT1/2	9	6	22	27	49
HN-7410	PT1/2	10.5	7	22	27	49
HN-7412	PT1/2	12	8	22	27	49
HN-7440	PT1/2	12.7	8	22	27	49
HN-7413	PT1/2	13.5	10	22	27	49
HN-7414	PT1/2	14	11	22	27	49
HN-7416	PT1/2	16	12	22	27	49
HN-7419	PT1/2	19	14	22	27	49
HN-7420	PT1/2	20.5	15	22	27	49
HN-7421	PT1/2	21	15	22	27	49
HN-7616	PT3/4	16	11	27	33	59
HN-7619	PT3/4	19	14	27	33	59
HN-7620	PT3/4	20.5	15	27	33	59
HN-7621	PT3/4	21	16	27	33	59
HN-7626	PT3/4	26	20	27	33	59
HN-7627	PT3/4	27	20	29	33	59
HN-7820	PT 1	20.5	15	35	40	70
HN-7827	PT 1	27	22	35	40	70
HN-7834	PT 1	34	25	35	40	70
*HN-7034	PT1 1/4	34	25	44	45	80
*HN-7040	PT1 1/2	40	31	52	53	90
*HN-7052	PT 2	52	43	63	60	100
*HN-7066	PT2 1/2	66	53	80	71	120
*HN-7078	PT 3	78	65	93	78	130
*HN-7100	PT 4	100	88	120	92	150

品番の前の※印はSCS13

エースジョイント

SUS304

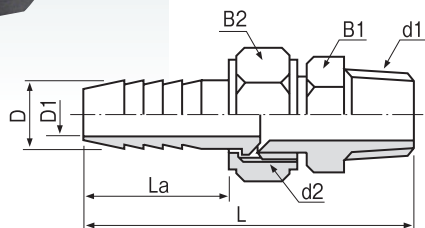

品番	寸法 (mm)							
	d1	φD	φD1	B1	B2	d2	La	L(約)
HS-7107	PT1/8	7	4	12	12	PF1/8	20	44
HS-7208	PT1/4	8	5	14	16	PF1/4	24	57
HS-7209	PT1/4	9	5	14	16	PF1/4	24	57
HS-7310	PT3/8	10.5	7	17	19	PF3/8	25	60
HS-7414	PT1/2	14	10.5	22	24	PF1/2	27	69
HS-7416	PT1/2	16	11.5	22	24	PF1/2	27	69
HS-7620	PT3/4	20.5	15	29	30	PF3/4	33	80

内ネジ・エースニップル

SUS304

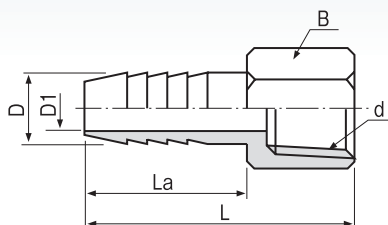

品番	寸法 (mm)					
	d	φD	φD1	B	La	L(約)
HF-7207	PT1/4	7	4	17	26	45
HF-7208	PT1/4	8	4.5	17	26	45
HF-7209	PT1/4	9	5	17	26	45
HF-7210	PT1/4	10.5	7	17	26	45
HF-7310	PT3/8	10.5	7	22	28	49
HF-7312	PT3/8	12	8	22	28	49
HF-7314	PT3/8	14	10	22	28	49
HF-7410	PT1/2	10.5	7	24	29	54
HF-7412	PT1/2	12	8	24	29	54
HF-7414	PT1/2	14	10	24	29	54
HF-7416	PT1/2	16	11	24	29	54

三方接手

SCS13

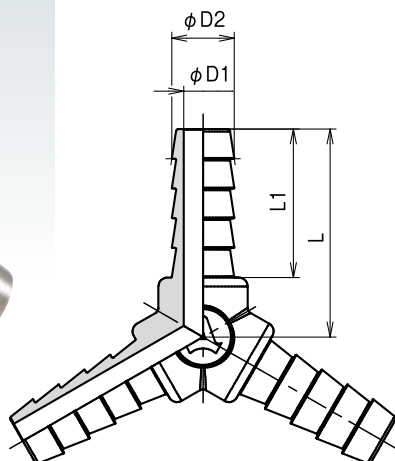
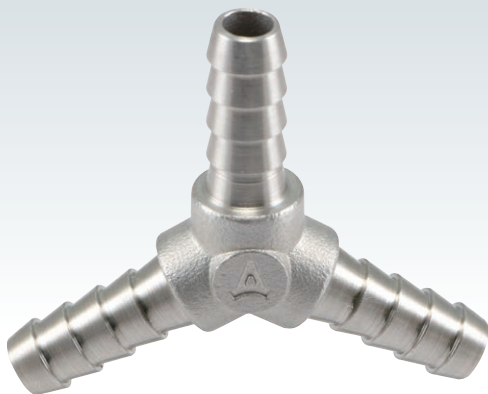

品番	寸法 (mm)			
	φD1	φD2	L1	L
HY-7007	4	7	18	27
HY-7009	5	9	18	27
HY-7010	6.5	10.5	25	35

ホースニップル

C3604BD

一部C3771BDもあります。

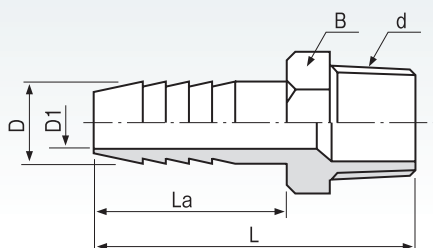
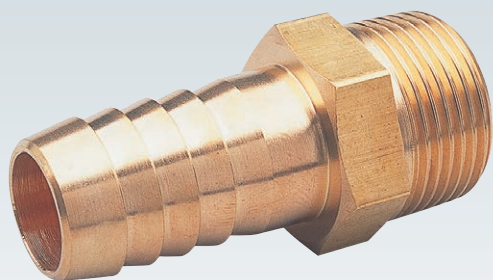

品番	RoHS品番	取付ネジ	寸法 (mm)				
			d	φD	φD1	B	La
HN-1105		PT1/8	5	2.5	12	20	34
HN-1106	HN-1106R	PT1/8	6	3	12	20	34
HN-1165		PT1/8	6.5	3.5	12	20	34
HN-1107	HN-1107R	PT1/8	7	4	12	20	34
HN-1108	HN-1108R	PT1/8	8	5	12	20	34
HN-1109		PT1/8	9	5.5	12	20	34
HN-1110	HN-1110R	PT1/8	10.5	6	12	20	34
HN-1112		PT1/8	12	6	12	20	34
HN-1206		PT1/4	6	3	14	26	41
HN-1265		PT1/4	6.5	3.5	14	26	41
HN-1207	HN-1207R	PT1/4	7	4	14	26	41
HN-1208	HN-1208R	PT1/4	8	4.5	14	26	41
HN-1209	HN-1209R	PT1/4	9	5	14	26	41
HN-1295		PT1/4	9.5	5.5	14	26	41
HN-1210	HN-1210R	PT1/4	10.5	7	14	26	41
HN-1212	HN-1212R	PT1/4	12	8.5	14	26	41
HN-1240		PT1/4	12.7	9	14	26	41
HN-1213		PT1/4	13	9	14	26	41
HN-1214	HN-1214R	PT1/4	14	9	14	26	41
HN-1216		PT1/4	16	9	17	29	46
HN-1306		PT3/8	6	3	17	29	46
HN-1307	HN-1307R	PT3/8	7	4	17	29	46
HN-1308		PT3/8	8	4.5	17	29	46
HN-1309		PT3/8	9	5.5	17	29	46
HN-1395		PT3/8	9.5	5.5	17	29	46
HN-1310	HN-1310R	PT3/8	10.5	7	17	29	46
HN-1312		PT3/8	12	8	17	29	46
HN-1340		PT3/8	12.7	8.5	17	29	46
HN-1313		PT3/8	13.5	9.5	17	29	46
HN-1314	HN-1314R	PT3/8	14	10	17	29	46
HN-1316	HN-1316R	PT3/8	16	11.5	17	29	46
HN-1406		PT1/2	6	3	22	29	50
HN-1407	HN-1407R	PT1/2	7	3.5	22	29	50
HN-1408		PT1/2	8	4	22	29	50
HN-1409		PT1/2	9	5	22	29	50
HN-1410	HN-1410R	PT1/2	10.5	6	22	29	50
HN-1412	HN-1412R	PT1/2	12	7.5	22	29	50
HN-1440	HN-1440R	PT1/2	12.7	8	22	29	50
HN-1413		PT1/2	13.5	9.5	22	29	50
HN-1414	HN-1414R	PT1/2	14	10	22	29	50
HN-1416	HN-1416R	PT1/2	16	11	22	29	50
HN-1419		PT1/2	19	14	22	29	50
HN-1420	HN-1420R	PT1/2	20.5	14	22	29	50
HN-1421		PT1/2	21	14	22	29	50
HN-1614		PT3/4	14	9.5	27	36	60
HN-1616	HN-1616R	PT3/4	16	10	27	36	60
HN-1619	HN-1619R	PT3/4	19	13	27	36	60
HN-1620	HN-1620R	PT3/4	20.5	15	27	36	60
HN-1621		PT3/4	21	15	27	36	60
HN-1626		PT3/4	26	19.5	27	36	60
HN-1627	HN-1627R	PT3/4	27	20	27	36	60
HN-1814		PT 1	14	9.5	35	36	68
*HN-1820		PT 1	20.5	14	35	42	74
*HN-1827	*HN-1827R	PT 1	27	20.5	35	41.5	73.5
HN-1834		PT 1	34	25.5	35	41.5	73.5

品番の前の*印はC3771BD

デカニップル 鍛造製

C3771BD

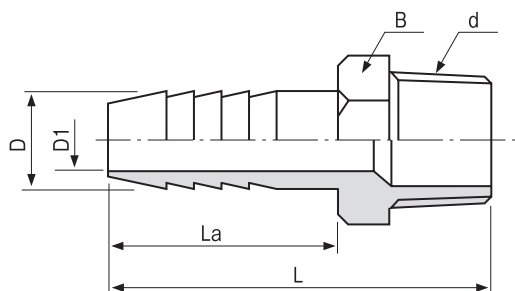
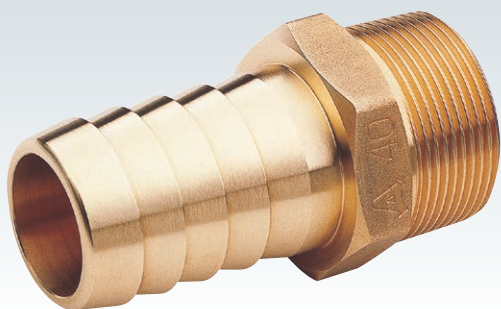

品番	RoHS 品番	取付ネジ	寸法 (mm)				
			d	φD	φD1	B	La
HN-1034	HN-1034R	PT1- $\frac{1}{4}$	34	24	45	58	96
HN-1040	HN-1040R	PT1- $\frac{1}{2}$	40	30	51	61	100
HN-1052	HN-1052R	PT2	52	40	63	86	132

内ネジホースニップル

C3604BD

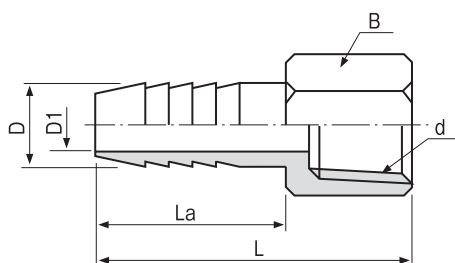
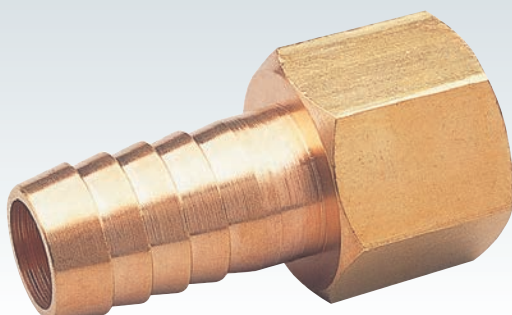

品番	取付ネジ	寸法 (mm)				
		d	φD	φD1	B	La
HF-1207	PT1/4	7	4	17	26	41
HF-1208	PT1/4	8	4.5	17	26	41
HF-1209	PT1/4	9	5.5	17	26	41
HF-1295	PT1/4	9.5	5.5	17	26	41
HF-1210	PT1/4	10.5	7	17	26	41
HF-1308	PT3/8	8	4.5	21	28	45
HF-1309	PT3/8	9	5.5	21	28	45
HF-1395	PT3/8	9.5	6	21	28	45
HF-1310	PT3/8	10.5	7	21	28	45
HF-1312	PT3/8	12	8	21	28	45
HF-1340	PT3/8	12.7	9.5	21	28	45
HF-1314	PT3/8	14	10	21	28	45
HF-1316	PT3/8	16	11.5	21	28	45
HF-1408	PT1/2	8	4.5	24	29	49
HF-1409	PT1/2	9	5.5	24	29	49
HF-1410	PT1/2	10.5	7	24	29	49
HF-1412	PT1/2	12	8	24	29	49
HF-1440	PT1/2	12.7	9.5	24	29	49
HF-1414	PT1/2	14	10	24	29	49
HF-1416	PT1/2	16	11.5	24	29	49

三方接手 (メッキ付)

C3771BD

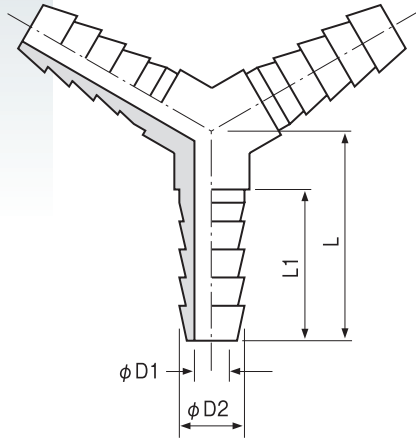
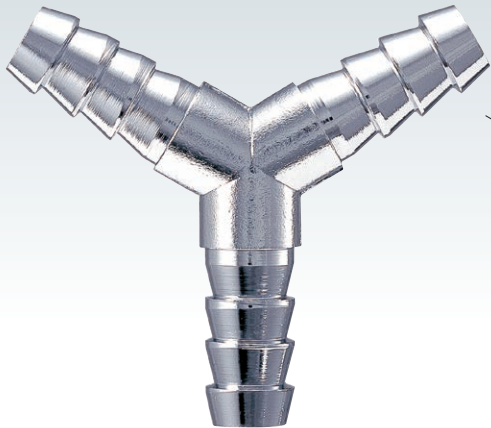

品番	寸法 (mm)			
	φD1	φD2	L1	L
HY-3007	4	7	18	27
HY-3008	4.5	8	18	27
HY-3009	5	9	18	27
HY-3010	7	10.5	25	35
HY-3014	9	14	25	35

ホース接手

C3604BD

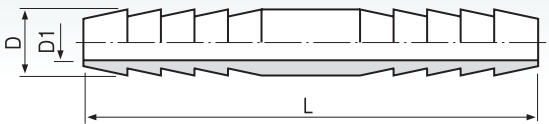

品番	寸法 (mm)		
	φD	φD1	L
HH-2006	6	3	55
HH-2007	7	4	55
HH-2008	8	5	65
HH-2009	9	6	65
HH-2010	10.5	8	70
HH-2012	12	8	70
HH-2040	12.7	8	70
HH-2014	14	10	75
HH-2016	16	11	80
HH-2019	19	15	90
HH-2020	20.5	16	90

水口ホースニップル (丸型)

C3604BD

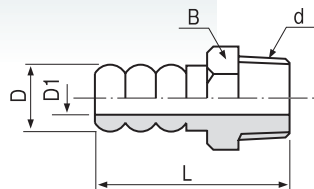

品番	取付ネジ	寸法 (mm)			
	d	φD	φD1	B	L
MH-1112	PT1/8	11	6	12	33
MH-1222	PT1/4	11	6	14	33

水口ホースニップル (角型)

C3604BD

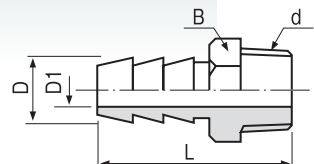
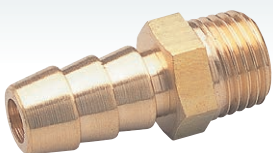

品番	取付ネジ	寸法 (mm)			
	d	φD	φD1	B	L
MH-1111	PT1/8	11	6	12	33
MH-1221	PT1/4	11	6	14	33

アングル型ホースニップル

C3771BD

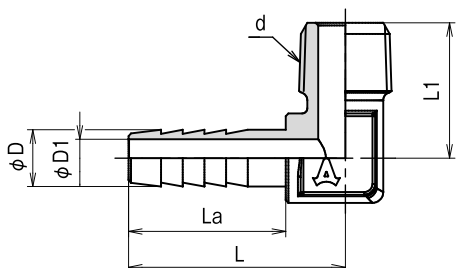

RoHS 品番	取付ネジ	寸法 (mm)				
		d	φD	φD1	L1	La
HA-1207R	PT1/4	7	4	22	26	40
HA-1208R	PT1/4	8	4.5	22	26	40
HA-1209R	PT1/4	9	5	22	26	40
HA-1210R	PT1/4	10.5	7	22	26	40
HA-1309R	PT3/8	9	5.5	25	29	40
HA-1310R	PT3/8	10.5	7	25	29	40
HA-1340R	PT3/8	12.7	8.5	25	29	40
HA-1314R	PT3/8	14	9.5	25	29	40
HA-1410R	PT1/2	10.5	6	31	29	48
HA-1440R	PT1/2	12.7	8	31	29	48
HA-1414R	PT1/2	14	10	31	29	48
HA-1416R	PT1/2	16	11	31	29	48
HA-1419R	PT1/2	19	14	31	29	48

ホースジョイント用竹の子

C3604BD

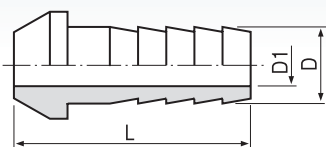

品番	RoHS 品番	寸法 (mm)		
		φD	φD1	L
HSH-1106	HSH-1106R	6	3	24
HSH-1107	HSH-1107R	7	4	24
HSH-1206	HSH-1206R	6	3	34.5
HSH-1207	HSH-1207R	7	4	34.5
HSH-1208	HSH-1208R	8	4.5	34.5
HSH-1209	HSH-1209R	9	5	34.5
HSH-1310	HSH-1310R	10.5	7	36
HSH-1440	HSH-1440R	12.7	9	42
HSH-1414	HSH-1414R	14	10	42
HSH-1416	HSH-1416R	16	11.5	42
HSH-1620	HSH-1620R	20.5	15	46
HSH-1827	HSH-1827R	27	20	60

ホースジョイント用袋ナット

C3604BD

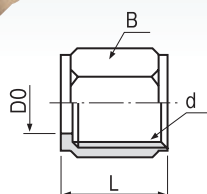

品番	RoHS 品番	取付ネジ	寸法 (mm)		
			d	φD0	B
HSN-1106	HSN-1106R	PF1/8	7.3	12	10
HSN-1107	HSN-1107R	PF1/8	7.3	12	10
HSN-1206	HSN-1206R	PF1/4	9.5	16	13
HSN-1207	HSN-1207R	PF1/4	9.5	16	13
HSN-1208	HSN-1208R	PF1/4	9.5	16	13
HSN-1209	HSN-1209R	PF1/4	9.5	16	13
HSN-1310	HSN-1310R	PF3/8	11	19	14
HSN-1440	HSN-1440R	PF1/2	16.5	24	16
HSN-1414	HSN-1414R	PF1/2	16.5	24	16
HSN-1416	HSN-1416R	PF1/2	16.5	24	16
HSN-1620	HSN-1620R	PF3/4	21.4	30	17.5
HSN-1827	HSN-1827R	PF 1	27.5	38	20

ホースジョイント

C3604BD

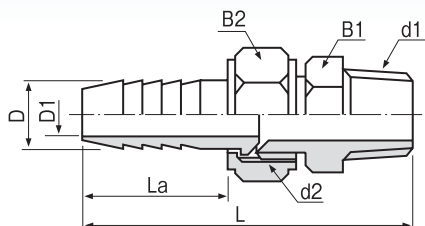
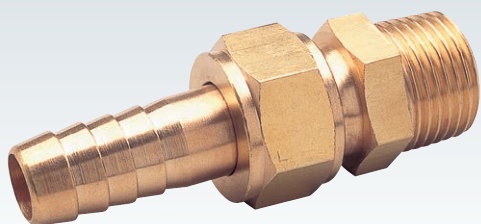

品番	RoHS品番	取付ネジ	寸法 (mm)						
			d1	φD	φD1	B1	B2	d2	La
HS-1116		PT1/8	6	3	12	12	PF1/8	19	43
HS-1117	HS-1117R	PT1/8	7	4	12	12	PF1/8	19	43
HS-1107		PT1/8	7	4	14	16	PF1/4	26	55
HS-1108		PT1/8	8	4.5	14	16	PF1/4	26	55
HS-1109		PT1/8	9	5	14	16	PF1/4	26	55
HS-1206		PT1/4	6	3	14	16	PF1/4	26	59
HS-1207	HS-1207R	PT1/4	7	4	14	16	PF1/4	26	59
HS-1208	HS-1208R	PT1/4	8	4.5	14	16	PF1/4	26	59
HS-1209	HS-1209R	PT1/4	9	5	14	16	PF1/4	26	59
HS-1210	HS-1210R	PT1/4	10.5	7	17	19	PF3/8	26.5	59
HS-1306		PT3/8	6	3	17	16	PF1/4	26	60
HS-1307	HS-1307R	PT3/8	7	4	17	16	PF1/4	26	60
HS-1308		PT3/8	8	4.5	17	16	PF1/4	26	60
HS-1309		PT3/8	9	5	17	16	PF1/4	26	60
HS-1310	HS-1310R	PT3/8	10.5	7	17	19	PF3/8	26.5	61
HS-1340		PT3/8	12.7	9	22	24	PF1/2	31	70
HS-1314	HS-1314R	PT3/8	14	10	22	24	PF1/2	31	70
HS-1316	HS-1316R	PT3/8	16	11.5	22	24	PF1/2	31	70
HS-1408		PT1/2	8	4.5	22	16	PF1/4	26	63
HS-1409		PT1/2	9	5	22	16	PF1/4	26	63
HS-1410	HS-1410R	PT1/2	10.5	7	22	19	PF3/8	26.5	63
HS-1440		PT1/2	12.7	9	22	24	PF1/2	31	73
HS-1414	HS-1414R	PT1/2	14	10	22	24	PF1/2	31	73
HS-1416	HS-1416R	PT1/2	16	11.5	22	24	PF1/2	31	73
HS-1420	HS-1420R	PT1/2	20.5	15	27	30	PF3/4	34.5	78
HS-1640		PT3/4	12.7	9	27	24	PF1/2	31	76
HS-1614	HS-1614R	PT3/4	14	10	27	24	PF1/2	31	76
HS-1616		PT3/4	16	11.5	27	24	PF1/2	31	76
HS-1620	HS-1620R	PT3/4	20.5	15	28	30	PF3/4	34.5	82
HS-1827	HS-1827R	PT 1	27	20	35	38	PF 1	47	105
HS-1034		PT1 1/4	34	24	45	46	PF1 1/4	70	142
HS-1040		PT1 1/2	40	28	50	55	PF1 1/2	74	147
HS-1052		PT 2	52	40	60	65	PF 2	93	178

両口ホースジョイント

C3604BD

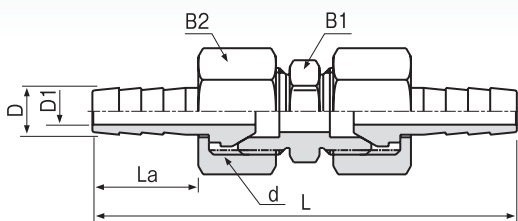
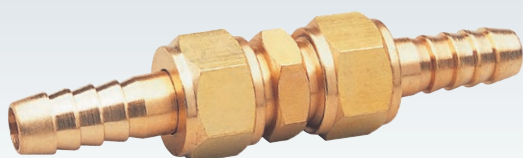

品番	RoHS品番	寸法 (mm)						
		φD	φD1	B1	B2	d	La	L(約)
HS-2207	HS-2207R	7	4	14	16	PF1/4	26	89
HS-2208	HS-2208R	8	4.5	14	16	PF1/4	26	89
HS-2209	HS-2209R	9	5	14	16	PF1/4	26	89
HS-2310	HS-2310R	10.5	7	17	19	PF3/8	27	91
HS-2440		12.7	9	22	24	PF1/2	31	112
HS-2414	HS-2414R	14	10	22	24	PF1/2	31	112
HS-2416	HS-2416R	16	11.5	22	24	PF1/2	31	112
HS-2620	HS-2620R	20.5	15	27	30	PF3/4	35	120
HS-2827		27	20	35	38	PF 1	47	158

L型ホースジョイント

C3604BD

C3771BD

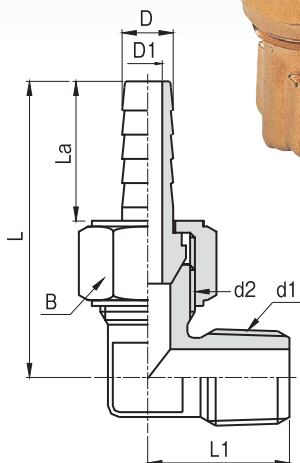

品番	RoHS 品番	取付ネジ	寸法 (mm)						
			d1	φD	φD1	B	d2	L1	La
HL-1116		PT1/8	6	3	12	PF1/8	17	19	36
HL-1117	HL-1117R	PT1/8	7	4	12	PF1/8	17	19	36
HL-1206		PT1/4	6	3	16	PF1/4	22	26	50
HL-1207	HL-1207R	PT1/4	7	4	16	PF1/4	22	26	50
HL-1208	HL-1208R	PT1/4	8	4.5	16	PF1/4	22	26	50
HL-1209	HL-1209R	PT1/4	9	5	16	PF1/4	22	26	50
HL-1210	HL-1210R	PT1/4	10.5	7	19	PF3/8	24	26.5	52
HL-1308		PT3/8	8	4.5	16	PF1/4	25	26	52
HL-1309		PT3/8	9	5	16	PF1/4	25	26	52
HL-1310	HL-1310R	PT3/8	10.5	7	19	PF3/8	25	26.5	52
HL-1340		PT3/8	12.7	9	24	PF1/2	28	31	64
HL-1314	HL-1314R	PT3/8	14	10	24	PF1/2	28	31	64
HL-1316	HL-1316R	PT3/8	16	11.5	24	PF1/2	28	31	64
HL-1408	HL-1408R	PT1/2	8	4.5	16	PF1/4	29	26	57
HL-1409		PT1/2	9	5	16	PF1/4	29	26	57
HL-1410		PT1/2	10.5	7	19	PF3/8	29	26.5	57
HL-1440		PT1/2	12.7	9	24	PF1/2	29	31	64
HL-1414	HL-1414R	PT1/2	14	10	24	PF1/2	29	31	64
HL-1416	HL-1416R	PT1/2	16	11.5	24	PF1/2	29	31	64
HL-1620		PT3/4	20.5	15	30	PF3/4	34	34.5	72

Y型ホースジョイント

C3604BD

(メッキ付)

C3771BD

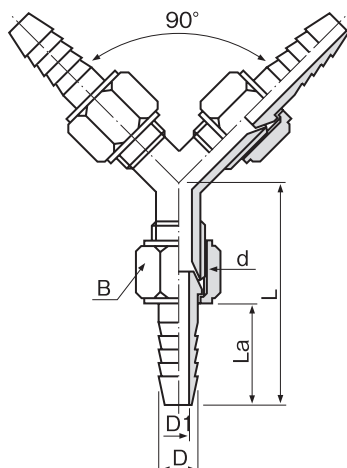
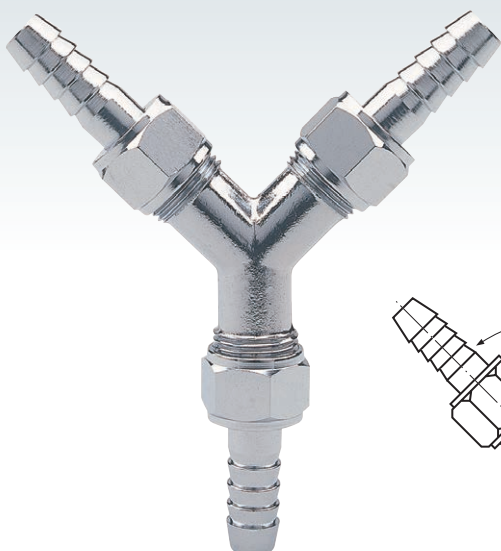

品番	寸法 (mm)					
	φD	φD1	B	d	La	L
HY-3208	8	4.5	16	PF1/4	26	53
HY-3209	9	5	16	PF1/4	26	53
HY-3310	10.5	7	19	PF3/8	26.5	55

リングジョイント

C3604BD

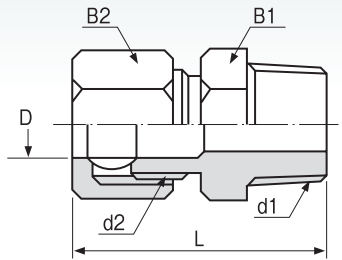
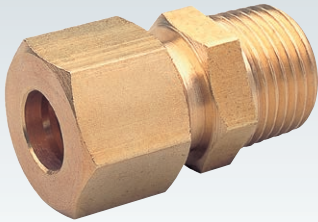

品番	取付ネジ	適用管外径	寸法 (mm)			
	d1	φD	B1	B2	d2	L(約)
RS-1104	PT1/8	4	12	12	PF1/8	26
RS-1105	PT1/8	5	12	12	PF1/8	26
RS-1106	PT1/8	6	12	12	PF1/8	27
RS-1102	PT1/8	6.35	14	17	PF1/4	30
RS-1108	PT1/8	8	14	17	PF1/4	31
RS-1103	PT1/8	9.53	17	21	PF3/8	33
RS-1110	PT1/8	10	17	21	PF3/8	33
RS-1206	PT1/4	6	14	17	PF1/4	32
RS-1202	PT1/4	6.35	14	17	PF1/4	32
RS-1208	PT1/4	8	14	17	PF1/4	33
RS-1203	PT1/4	9.53	17	21	PF3/8	35
RS-1210	PT1/4	10	17	21	PF3/8	35
RS-1212	PT1/4	12	22	24	PF1/2	42
RS-1204	PT1/4	12.7	22	24	PF1/2	43
RS-1306	PT3/8	6	17	17	PF1/4	35
RS-1302	PT3/8	6.35	17	17	PF1/4	35
RS-1308	PT3/8	8	17	17	PF1/4	36
RS-1303	PT3/8	9.53	17	21	PF3/8	38
RS-1310	PT3/8	10	17	21	PF3/8	38
RS-1312	PT3/8	12	22	24	PF1/2	42
RS-1304	PT3/8	12.7	22	24	PF1/2	43
RS-1315	PT3/8	15	24	27	PF5/8	43
RS-1305	PT3/8	15.88	24	27	PF5/8	44
RS-1406	PT1/2	6	22	17	PF1/4	38
RS-1402	PT1/2	6.35	22	17	PF1/4	38
RS-1408	PT1/2	8	22	17	PF1/4	39
RS-1403	PT1/2	9.53	22	21	PF3/8	41
RS-1410	PT1/2	10	22	21	PF3/8	41
RS-1412	PT1/2	12	22	24	PF1/2	45
RS-1404	PT1/2	12.7	22	24	PF1/2	46
RS-1415	PT1/2	15	24	27	PF5/8	46
RS-1405	PT1/2	15.88	24	27	PF5/8	47
RS-1460	PT1/2	19.05	27	30	PF3/4	50
RS-1612	PT3/4	12	27	24	PF1/2	48
RS-1604	PT3/4	12.7	27	24	PF1/2	49
RS-1615	PT3/4	15	27	27	PF5/8	49
RS-1605	PT3/4	15.88	27	27	PF5/8	50
RS-1606	PT3/4	19.05	27	30	PF3/4	52

両口リングジョイント

C3604BD

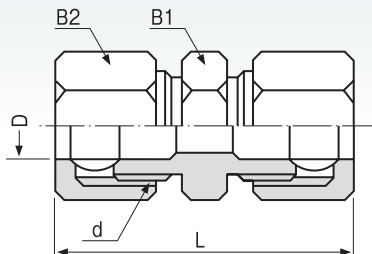
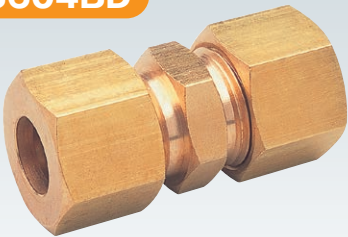

品番	適用管外径	寸法 (mm)			
	φD	B1	B2	d	L(約)
RS-2104	4	12	12	PF1/8	30
RS-2105	5	12	12	PF1/8	31
RS-2106	6	12	12	PF1/8	32
RS-2206	6	14	17	PF1/4	40
RS-2202	6.35	14	17	PF1/4	40
RS-2208	8	14	17	PF1/4	42
RS-2303	9.53	17	21	PF3/8	45
RS-2310	10	17	21	PF3/8	46
RS-2412	12	22	24	PF1/2	56
RS-2404	12.7	22	24	PF1/2	57
RS-2515	15	24	27	PF5/8	57
RS-2505	15.88	24	27	PF5/8	58
RS-2606	19.05	27	30	PF3/4	65

内ネジ・リングジョイント

C3604BD

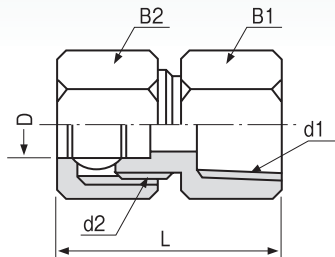
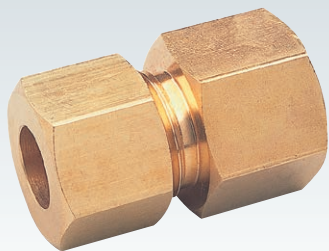

品番	取付ネジ	適用管外径 ϕD	寸法 (mm)			
	d1		B1	B2	d2	L(約)
RF-1104	PT1/8	4	14	12	PF1/8	26
RF-1105	PT1/8	5	14	12	PF1/8	26
RF-1106	PT1/8	6	14	12	PF1/8	27
RF-1108	PT1/8	8	14	17	PF1/4	31
RF-1206	PT1/4	6	17	17	PF1/4	32
RF-1202	PT1/4	6.35	17	17	PF1/4	32
RF-1208	PT1/4	8	17	17	PF1/4	33
RF-1203	PT1/4	9.53	17	21	PF3/8	35
RF-1210	PT1/4	10	17	21	PF3/8	35
RF-1306	PT3/8	6	21	17	PF1/4	35
RF-1302	PT3/8	6.35	21	17	PF1/4	35
RF-1308	PT3/8	8	21	17	PF1/4	36
RF-1303	PT3/8	9.53	21	21	PF3/8	38
RF-1310	PT3/8	10	21	21	PF3/8	38
RF-1312	PT3/8	12	22	24	PF1/2	41
RF-1304	PT3/8	12.7	22	24	PF1/2	42
RF-1406	PT1/2	6	26	17	PF1/4	37
RF-1402	PT1/2	6.35	26	17	PF1/4	37
RF-1408	PT1/2	8	26	17	PF1/4	38
RF-1403	PT1/2	9.53	26	21	PF3/8	40
RF-1410	PT1/2	10	26	21	PF3/8	40
RF-1412	PT1/2	12	26	24	PF1/2	44
RF-1404	PT1/2	12.7	26	24	PF1/2	45
RF-1415	PT1/2	15	28	27	PF5/8	45
RF-1405	PT1/2	15.88	28	27	PF5/8	46

ゲージジョイント

C3604BD

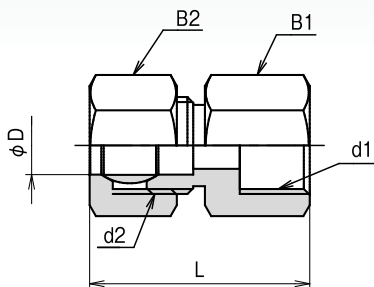
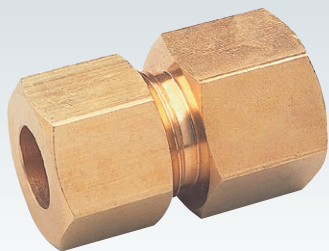

品番	取付ネジ	適用管外径 ϕD	寸法 (mm)			
	d1		B1	B2	d2	L(約)
RG-1206	PF1/4	6	17	17	PF1/4	32
RG-1202	PF1/4	6.35	17	17	PF1/4	32
RG-1208	PF1/4	8	17	17	PF1/4	33
RG-1203	PF1/4	9.53	17	21	PF3/8	35
RG-1210	PF1/4	10	17	21	PF3/8	35
RG-1306	PF3/8	6	21	17	PF1/4	35
RG-1302	PF3/8	6.35	21	17	PF1/4	35
RG-1308	PF3/8	8	21	17	PF1/4	36
RG-1303	PF3/8	9.53	21	21	PF3/8	38
RG-1310	PF3/8	10	21	21	PF3/8	38

異径両口 リングジョイント

C3604BD

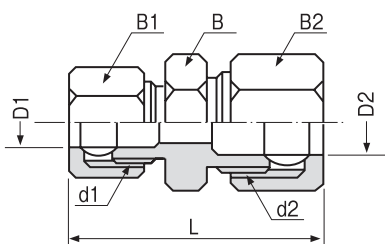
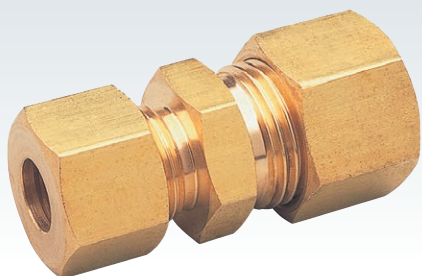

品番	適用管外径		寸法 (mm)					
	$\phi D1$	$\phi D2$	B	B1	B2	d1	d2	L(約)
RE-0602	6	6.35	14	17	17	PF1/4	PF1/4	40
RE-0608	6	8	14	17	17	PF1/4	PF1/4	41
RE-0603	6	9.53	17	17	21	PF1/4	PF3/8	43
RE-0610	6	10	17	17	21	PF1/4	PF3/8	43
RE-0208	6.35	8	14	17	17	PF1/4	PF1/4	41
RE-0203	6.35	9.53	17	17	21	PF1/4	PF3/8	43
RE-0210	6.35	10	17	17	21	PF1/4	PF3/8	43
RE-0803	8	9.53	17	17	21	PF1/4	PF3/8	44
RE-0810	8	10	17	17	21	PF1/4	PF3/8	44
RE-0310	9.53	10	17	21	21	PF3/8	PF3/8	45
RE-0312	9.53	12	22	21	24	PF3/8	PF1/2	51
RE-0304	9.53	12.7	22	21	24	PF3/8	PF1/2	52
RE-0315	9.53	15	24	21	27	PF3/8	PF5/8	51
RE-0305	9.53	15.88	24	21	27	PF3/8	PF5/8	52
RE-1012	10	12	22	21	24	PF3/8	PF1/2	51
RE-1004	10	12.7	22	21	24	PF3/8	PF1/2	52
RE-1015	10	15	24	21	27	PF3/8	PF5/8	52
RE-1005	10	15.88	24	21	27	PF3/8	PF5/8	53
RE-1204	12	12.7	22	24	24	PF1/2	PF1/2	56
RE-1215	12	15	24	24	27	PF1/2	PF5/8	56
RE-1205	12	15.88	24	24	27	PF1/2	PF5/8	57
RE-0415	12.7	15	24	24	27	PF1/2	PF5/8	57
RE-0405	12.7	15.88	24	24	27	PF1/2	PF5/8	58

両口ロックナット付 リングジョイント

C3604BD

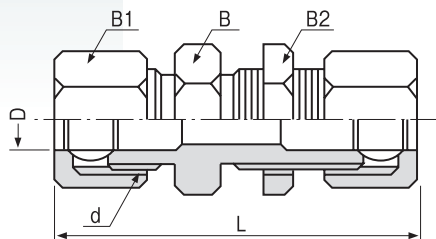

品番	適用管外径	寸法 (mm)				
	ϕD	B	B1	B2	d	L(約)
RW-2206	6	17	17	17	PF1/4	52
RW-2202	6.35	17	17	17	PF1/4	52
RW-2208	8	17	17	17	PF1/4	53
RW-2303	9.53	19	21	19	PF3/8	59
RW-2310	10	19	21	19	PF3/8	60
RW-2412	12	23	24	23	PF1/2	73
RW-2404	12.7	23	24	23	PF1/2	74

ロックナット

C3604BD

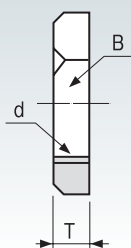

品番	RoHS品番	寸法 (mm)		
		d	B	T
NR-1001	NR-1001R	PF1/8	15	4
NR-1002	NR-1002R	PF1/4	17	5
NR-1003	NR-1003R	PF3/8	19	5
NR-1004	NR-1004R	PF1/2	23	6
NR-1006	NR-1006R	PF3/4	30	7

リングエルボ

C3604BD

C3771BD

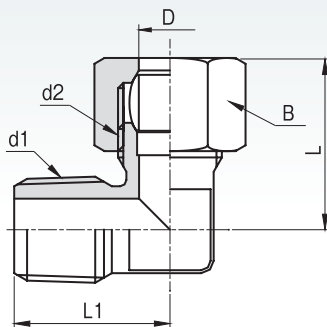

品番	取付ネジ	適用管外径 φD	寸法 (mm)			
	d1		B	d2	L1	L(約)
RL-1104	PT1/8	4	12	PF1/8	17	19
RL-1105	PT1/8	5	12	PF1/8	17	19
RL-1106	PT1/8	6	12	PF1/8	17	20
RL-1102	PT1/8	6.35	17	PF1/4	19	25
RL-1108	PT1/8	8	17	PF1/4	19	26
RL-1103	PT1/8	9.53	21	PF3/8	21	30
RL-1110	PT1/8	10	21	PF3/8	21	30
RL-1206	PT1/4	6	17	PF1/4	22	25
RL-1202	PT1/4	6.35	17	PF1/4	22	25
RL-1208	PT1/4	8	17	PF1/4	22	26
RL-1203	PT1/4	9.53	21	PF3/8	24	30
RL-1210	PT1/4	10	21	PF3/8	24	30
RL-1212	PT1/4	12	24	PF1/2	28	36
RL-1204	PT1/4	12.7	24	PF1/2	28	37
RL-1306	PT3/8	6	17	PF1/4	25	27
RL-1302	PT3/8	6.35	17	PF1/4	25	27
RL-1308	PT3/8	8	17	PF1/4	25	28
RL-1303	PT3/8	9.53	21	PF3/8	25	30
RL-1310	PT3/8	10	21	PF3/8	25	30
RL-1312	PT3/8	12	24	PF1/2	28	36
RL-1304	PT3/8	12.7	24	PF1/2	28	37
RL-1315	PT3/8	15	27	PF5/8	33	41
RL-1305	PT3/8	15.88	27	PF5/8	33	41
RL-1406	PT1/2	6	17	PF1/4	29	32
RL-1402	PT1/2	6.35	17	PF1/4	29	32
RL-1408	PT1/2	8	17	PF1/4	29	33
RL-1403	PT1/2	9.53	21	PF3/8	29	35
RL-1410	PT1/2	10	21	PF3/8	29	35
RL-1412	PT1/2	12	24	PF1/2	29	36
RL-1404	PT1/2	12.7	24	PF1/2	29	37
RL-1415	PT1/2	15	27	PF5/8	32	41
RL-1405	PT1/2	15.88	27	PF5/8	32	41
RL-1460	PT1/2	19.05	30	PF3/4	32	44
RL-1612	PT3/4	12	24	PF1/2	34	39
RL-1604	PT3/4	12.7	24	PF1/2	34	40
RL-1615	PT3/4	15	27	PF5/8	34	41
RL-1605	PT3/4	15.88	27	PF5/8	34	41
RL-1606	PT3/4	19.05	30	PF3/4	34	44

内ネジ・リングエルボ

C3604BD

C3771BD

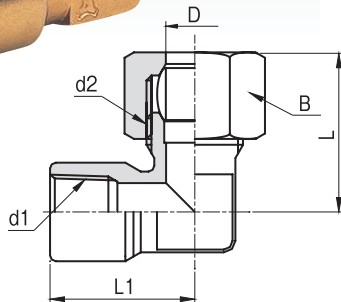
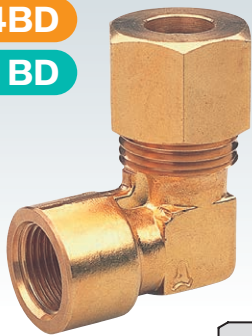

品番	取付ネジ	適用管外径	寸法 (mm)			
	d1	φD	B	d2	L1	L(約)
RL-5106	PT1/8	6	17	PF1/4	22	27
RL-5206	PT1/4	6	17	PF1/4	25	29
RL-5202	PT1/4	6.35	17	PF1/4	25	29
RL-5208	PT1/4	8	17	PF1/4	25	31
RL-5203	PT1/4	9.53	21	PF3/8	25	30
RL-5210	PT1/4	10	21	PF3/8	25	30
RL-5303	PT3/8	9.53	21	PF3/8	29	36
RL-5310	PT3/8	10	21	PF3/8	29	36
RL-5312	PT3/8	12	24	PF1/2	29	36
RL-5304	PT3/8	12.7	24	PF1/2	29	37

両口リングエルボ

C3604BD

C3771BD

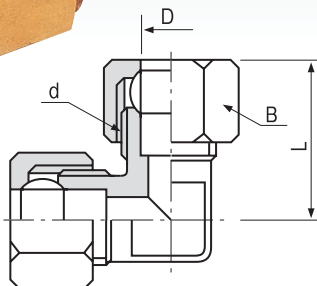
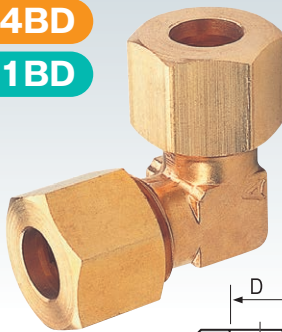

品番	適用管外径	寸法 (mm)		
	φD	B	d	L(約)
RL-2104	4	12	PF1/8	19
RL-2105	5	12	PF1/8	19
RL-2106	6	12	PF1/8	20
RL-2206	6	17	PF1/4	25
RL-2202	6.35	17	PF1/4	25
RL-2208	8	17	PF1/4	26
RL-2303	9.53	21	PF3/8	30
RL-2310	10	21	PF3/8	30
RL-2412	12	24	PF1/2	36
RL-2404	12.7	24	PF1/2	37
RL-2515	15	27	PF5/8	41
RL-2505	15.88	27	PF5/8	41
RL-2606	19.05	30	PF3/4	44

三方リングチーズ

C3604BD

C3771BD

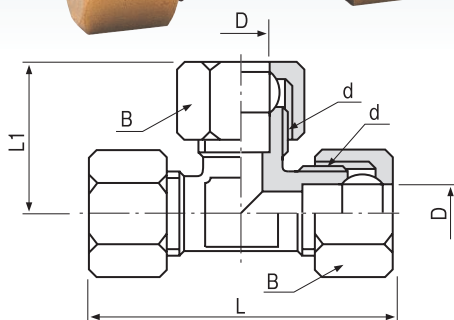
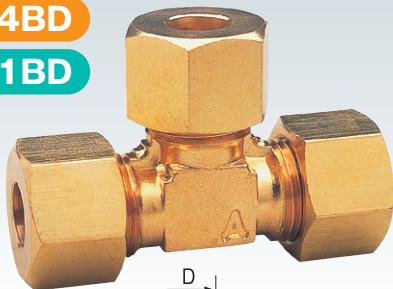

品番	適用管外径	寸法 (mm)			
	φD	B	d	L1(約)	L(約)
RT-3104	4	12	PF1/8	19	38
RT-3105	5	12	PF1/8	19	38
RT-3106	6	12	PF1/8	20	40
RT-3206	6	17	PF1/4	25	50
RT-3202	6.35	17	PF1/4	25	50
RT-3208	8	17	PF1/4	26	52
RT-3303	9.53	21	PF3/8	30	60
RT-3310	10	21	PF3/8	30	60
RT-3412	12	24	PF1/2	36	72
RT-3404	12.7	24	PF1/2	37	74
RT-3515	15	27	PF5/8	41	82
RT-3505	15.88	27	PF5/8	41	82
RT-3606	19.05	30	PF3/4	44	88

サービス・リングチーズ

C3604BD

C3771BD

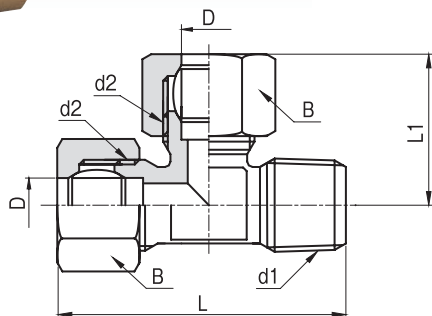

品番	取付ネジ	適用管外径	寸法 (mm)			
	d1		φD	B	d2	L1 (約)
RT-4106	PT1/8	6	12	PF1/8	20	37
RT-4206	PT1/4	6	17	PF1/4	25	47
RT-4202	PT1/4	6.35	17	PF1/4	25	47
RT-4208	PT1/4	8	17	PF1/4	26	48
RT-4303	PT3/8	9.53	21	PF3/8	30	55
RT-4310	PT3/8	10	21	PF3/8	30	55
RT-4403	PT1/2	9.53	21	PF3/8	35	64
RT-4410	PT1/2	10	21	PF3/8	35	64

二方リングチーズ

C3604BD

C3771BD

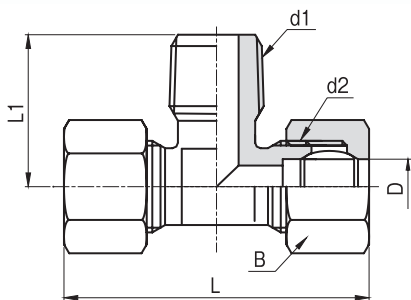
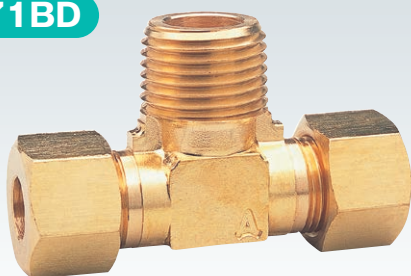

品番	取付ネジ	適用管外径	寸法 (mm)			
	d1		φD	B	d2	L1
RT-2104	PT1/8	4	12	PF1/8	17	38
RT-2105	PT1/8	5	12	PF1/8	17	38
RT-2106	PT1/8	6	12	PF1/8	17	40
RT-2102	PT1/8	6.35	17	PF1/4	19	50
RT-2108	PT1/8	8	17	PF1/4	19	52
RT-2206	PT1/4	6	17	PF1/4	22	50
RT-2202	PT1/4	6.35	17	PF1/4	22	50
RT-2208	PT1/4	8	17	PF1/4	22	52
RT-2203	PT1/4	9.53	21	PF3/8	24	60
RT-2210	PT1/4	10	21	PF3/8	24	60
RT-2306	PT3/8	6	17	PF1/4	25	54
RT-2302	PT3/8	6.35	17	PF1/4	25	54
RT-2308	PT3/8	8	17	PF1/4	25	56
RT-2303	PT3/8	9.53	21	PF3/8	25	60
RT-2310	PT3/8	10	21	PF3/8	25	60
RT-2312	PT3/8	12	24	PF1/2	28	72
RT-2304	PT3/8	12.7	24	PF1/2	28	74
RT-2403	PT1/2	9.53	21	PF3/8	29	70
RT-2410	PT1/2	10	21	PF3/8	29	70
RT-2412	PT1/2	12	24	PF1/2	29	72
RT-2404	PT1/2	12.7	24	PF1/2	29	74
RT-2415	PT1/2	15	27	PF5/8	32	82
RT-2405	PT1/2	15.88	27	PF5/8	32	82
RT-2606	PT3/4	19.05	30	PF3/4	34	88

リングナット

C3604BD

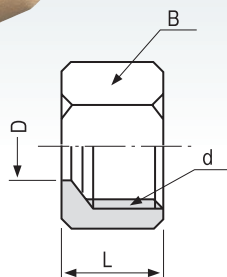

品番	適用管外径	寸法 (mm)		
	ϕD	d	B	L
RN-1004	4	PF1/8	12	10
RN-1005	5	PF1/8	12	10
RN-1016	6	PF1/8	12	11
RN-1026	6	PF1/4	17	13
*RN-1022	6.35	PF1/4	17	13
RN-1008	8	PF1/4	17	13
*RN-1033	9.53	PF3/8	21	15
RN-1010	10	PF3/8	21	15
RN-1012	12	PF1/2	24	18
*RN-1044	12.7	PF1/2	24	18
RN-1015	15	PF5/8	27	20
*RN-1055	15.88	PF5/8	27	20
RN-1066	19.05	PF3/4	30	23

*は六角カドにVミゾ入

リング玉

C3604BD

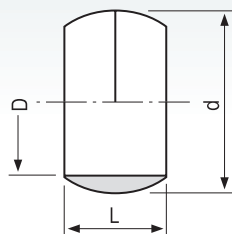

品番	適用管外径	寸法 (mm)	
	ϕD	d	L
RB-1004	4	6	5
RB-1005	5	7	5.5
RB-1016	6	8	6
RB-1026	6	9	6.5
RB-1022	6.35	9	6.5
RB-1008	8	10	7.5
RB-1033	9.53	13	9
RB-1010	10	13	9
RB-1012	12	14.8	10
RB-1044	12.7	15.5	10
RB-1015	15	18	12
RB-1055	15.88	19	12
RB-1066	19.05	22.5	13

フレアジョイント

C3604BD

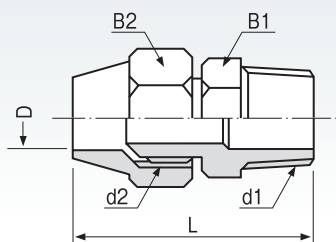

品番	取付ネジ	適用管外径 φD	寸法 (mm)			
	d1		B1	B2	d2	L (約)
FS-1106	PT1/8	6	12	16	UNF7/16×20	34
FS-1102	PT1/8	6.35	12	16	UNF7/16×20	34
FS-1108	PT1/8	8	14	17	UNF1/2 ×20	34
FS-1103	PT1/8	9.53	17	21	UNF5/8 ×18	36
FS-1110	PT1/8	10	17	21	UNF5/8 ×18	36
FS-1206	PT1/4	6	14	16	UNF7/16×20	37
FS-1202	PT1/4	6.35	14	16	UNF7/16×20	37
FS-1208	PT1/4	8	14	17	UNF1/2 ×20	37
FS-1203	PT1/4	9.53	17	21	UNF5/8 ×18	38
FS-1210	PT1/4	10	17	21	UNF5/8 ×18	38
FS-1212	PT1/4	12	22	24	UNF3/4 ×16	43
FS-1204	PT1/4	12.7	22	24	UNF3/4 ×16	43
FS-1306	PT3/8	6	17	16	UNF7/16×20	39
FS-1302	PT3/8	6.35	17	16	UNF7/16×20	39
FS-1308	PT3/8	8	17	17	UNF1/2 ×20	39
FS-1303	PT3/8	9.53	17	21	UNF5/8 ×18	40
FS-1310	PT3/8	10	17	21	UNF5/8 ×18	40
FS-1312	PT3/8	12	22	24	UNF3/4 ×16	45
FS-1304	PT3/8	12.7	22	24	UNF3/4 ×16	45
FS-1315	PT3/8	15	24	27	UNF7/8 ×14	49
FS-1305	PT3/8	15.88	24	27	UNF7/8 ×14	49
FS-1406	PT1/2	6	22	16	UNF7/16×20	42
FS-1402	PT1/2	6.35	22	16	UNF7/16×20	42
FS-1408	PT1/2	8	22	17	UNF1/2 ×20	42
FS-1403	PT1/2	9.53	22	21	UNF5/8 ×18	43
FS-1410	PT1/2	10	22	21	UNF5/8 ×18	43
FS-1412	PT1/2	12	22	24	UNF3/4 ×16	47
FS-1404	PT1/2	12.7	22	24	UNF3/4 ×16	47
FS-1415	PT1/2	15	24	27	UNF7/8 ×14	51
FS-1405	PT1/2	15.88	24	27	UNF7/8 ×14	51
FS-1615	PT3/4	15	28	27	UNF7/8 ×14	54
FS-1605	PT3/4	15.88	28	27	UNF7/8 ×14	54
FS-1606	PT3/4	19.05	28	32	UNS1 1/16 ×14	59

両口フレアジョイント

C3604BD

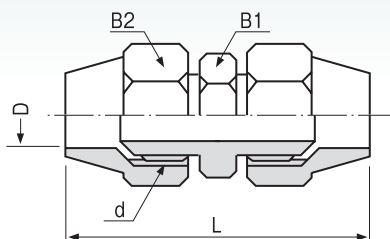
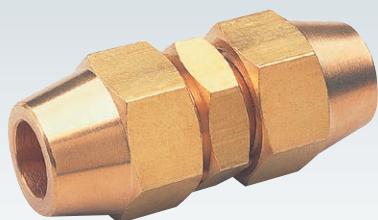

品番	適用管外径	寸法 (mm)			
	φD	B1	B2	d	L (約)
FS-2006	6	12	16	UNF7/16×20	46
FS-2022	6.35	12	16	UNF7/16×20	46
FS-2008	8	14	17	UNF1/2 ×20	46
FS-2033	9.53	17	21	UNF5/8 ×18	51
FS-2010	10	17	21	UNF5/8 ×18	51
FS-2012	12	22	24	UNF3/4 ×16	59
FS-2044	12.7	22	24	UNF3/4 ×16	59
FS-2015	15	24	27	UNF7/8 ×14	67
FS-2055	15.88	24	27	UNF7/8 ×14	67
FS-2066	19.05	28	32	UNS1 1/16 ×14	79

異径両口 フレアジョイント

C3604BD

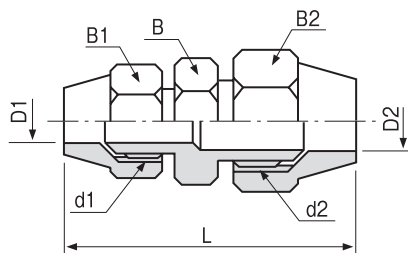
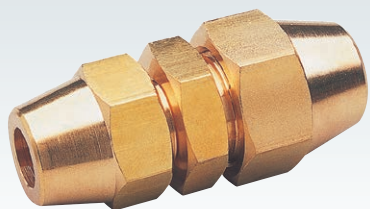

品番	適用管外径		寸法 (mm)					
	$\phi D1$	$\phi D2$	B	B1	B2	d1	d2	L (約)
FE-0602	6	6.35	12	16	16	UNF7/16×20	UNF7/16×20	46
FE-0608	6	8	14	16	17	UNF7/16×20	UNF1/2 ×20	46
FE-0603	6	9.53	17	16	21	UNF7/16×20	UNF5/8 ×18	49
FE-0610	6	10	17	16	21	UNF7/16×20	UNF5/8 ×18	49
FE-0208	6.35	8	14	16	17	UNF7/16×20	UNF1/2 ×20	46
FE-0203	6.35	9.53	17	16	21	UNF7/16×20	UNF5/8 ×18	49
FE-0210	6.35	10	17	16	21	UNF7/16×20	UNF5/8 ×18	49
FE-0803	8	9.53	17	17	21	UNF1/2 ×20	UNF5/8 ×18	49
FE-0810	8	10	17	17	21	UNF1/2 ×20	UNF5/8 ×18	49
FE-0310	9.53	10	17	21	21	UNF5/8 ×18	UNF5/8 ×18	51
FE-0312	9.53	12	22	21	24	UNF5/8 ×18	UNF3/4 ×16	55
FE-0304	9.53	12.7	22	21	24	UNF5/8 ×18	UNF3/4 ×16	55
FE-0315	9.53	15	24	21	27	UNF5/8 ×18	UNF7/8 ×14	59
FE-0305	9.53	15.88	24	21	27	UNF5/8 ×18	UNF7/8 ×14	59
FE-1012	10	12	22	21	24	UNF5/8 ×18	UNF3/4 ×16	55
FE-1004	10	12.7	22	21	24	UNF5/8 ×18	UNF3/4 ×16	55
FE-1015	10	15	24	21	27	UNF5/8 ×18	UNF7/8 ×14	59
FE-1005	10	15.88	24	21	27	UNF5/8 ×18	UNF7/8 ×14	59
FE-1204	12	12.7	22	24	24	UNF3/4 ×16	UNF3/4 ×16	59
FE-1215	12	15	24	24	27	UNF3/4 ×16	UNF7/8 ×14	63
FE-1205	12	15.88	24	24	27	UNF3/4 ×16	UNF7/8 ×14	63
FE-0415	12.7	15	24	24	27	UNF3/4 ×16	UNF7/8 ×14	63
FE-0405	12.7	15.88	24	24	27	UNF3/4 ×16	UNF7/8 ×14	63

内ネジ フレアジョイント

C3604BD

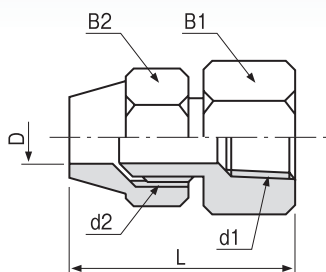
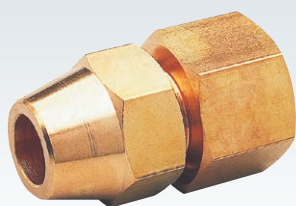

品番	取付ネジ	適用管外径	寸法 (mm)			
	d1		ϕD	B1	B2	d2
FF-1106	PT1/8	6	14	16	UNF7/16×20	34
FF-1102	PT1/8	6.35	14	16	UNF7/16×20	34
FF-1108	PT1/8	8	14	17	UNF1/2 ×20	34
FF-1206	PT1/4	6	17	16	UNF7/16×20	37
FF-1202	PT1/4	6.35	17	16	UNF7/16×20	37
FF-1208	PT1/4	8	17	17	UNF1/2 ×20	37
FF-1203	PT1/4	9.53	17	21	UNF5/8 ×18	37
FF-1210	PT1/4	10	17	21	UNF5/8 ×18	37
FF-1306	PT3/8	6	21	16	UNF7/16×20	39
FF-1302	PT3/8	6.35	21	16	UNF7/16×20	39
FF-1308	PT3/8	8	21	17	UNF1/2 ×20	39
FF-1303	PT3/8	9.53	21	21	UNF5/8 ×18	39
FF-1310	PT3/8	10	21	21	UNF5/8 ×18	39
FF-1312	PT3/8	12	21	24	UNF3/4 ×16	43
FF-1304	PT3/8	12.7	21	24	UNF3/4 ×16	43
FF-1408	PT1/2	8	26	17	UNF1/2 ×20	41
FF-1403	PT1/2	9.53	26	21	UNF5/8 ×18	41.5
FF-1410	PT1/2	10	26	21	UNF5/8 ×18	41.5
FF-1412	PT1/2	12	26	24	UNF3/4 ×16	45
FF-1404	PT1/2	12.7	26	24	UNF3/4 ×16	45
FF-1415	PT1/2	15	26	27	UNF7/8 ×14	49
FF-1405	PT1/2	15.88	26	27	UNF7/8 ×14	49

ゲージフィッティング

C3604BD

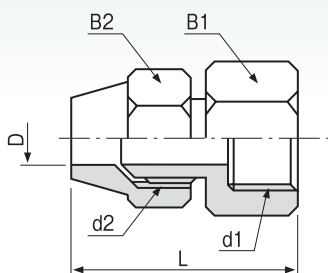
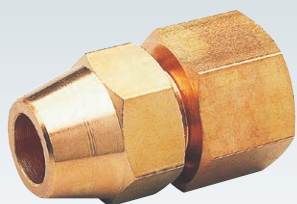

品番	取付ネジ	適用管外径 φD	寸法 (mm)			
	d1		B1	B2	d2	L(約)
FG-1206	PF1/4	6	17	16	UNF7/16×20	37
FG-1202	PF1/4	6.35	17	16	UNF7/16×20	37
FG-1208	PF1/4	8	17	17	UNF1/2 ×20	37
FG-1203	PF1/4	9.53	17	21	UNF5/8 ×18	37
FG-1210	PF1/4	10	17	21	UNF5/8 ×18	37
FG-1306	PF3/8	6	21	16	UNF7/16×20	39
FG-1302	PF3/8	6.35	21	16	UNF7/16×20	39
FG-1308	PF3/8	8	21	17	UNF1/2 ×20	39
FG-1303	PF3/8	9.53	21	21	UNF5/8 ×18	39
FG-1310	PF3/8	10	21	21	UNF5/8 ×18	39

フレアエルボ

C3604BD

C3771BD

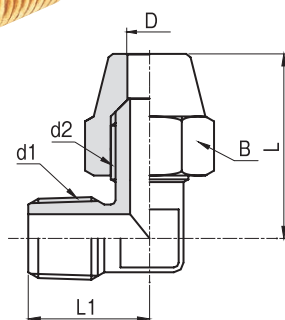
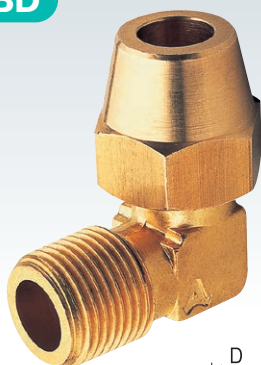

品番	取付ネジ	適用管外径 φD	寸法 (mm)			
	d1		B	d2	L1	L(約)
FL-1106	PT1/8	6	16	UNF7/16×20	19	29
FL-1102	PT1/8	6.35	16	UNF7/16×20	19	29
FL-1108	PT1/8	8	17	UNF1/2 ×20	19	29
FL-1103	PT1/8	9.53	21	UNF5/8 ×18	21	32
FL-1110	PT1/8	10	21	UNF5/8 ×18	21	32
FL-1206	PT1/4	6	16	UNF7/16×20	22	29
FL-1202	PT1/4	6.35	16	UNF7/16×20	22	29
FL-1208	PT1/4	8	17	UNF1/2 ×20	22	29
FL-1203	PT1/4	9.53	21	UNF5/8 ×18	24	32
FL-1210	PT1/4	10	21	UNF5/8 ×18	24	32
FL-1212	PT1/4	12	24	UNF3/4 ×16	29	40
FL-1204	PT1/4	12.7	24	UNF3/4 ×16	29	40
FL-1306	PT3/8	6	16	UNF7/16×20	25	31
FL-1302	PT3/8	6.35	16	UNF7/16×20	25	31
FL-1308	PT3/8	8	17	UNF1/2 ×20	25	31
FL-1303	PT3/8	9.53	21	UNF5/8 ×18	25	32
FL-1310	PT3/8	10	21	UNF5/8 ×18	25	32
FL-1312	PT3/8	12	24	UNF3/4 ×16	29	40
FL-1304	PT3/8	12.7	24	UNF3/4 ×16	29	40
FL-1406	PT1/2	6	16	UNF7/16×20	29	36
FL-1402	PT1/2	6.35	16	UNF7/16×20	29	36
FL-1408	PT1/2	8	17	UNF1/2 ×20	29	36
FL-1403	PT1/2	9.53	21	UNF5/8 ×18	29	37
FL-1410	PT1/2	10	21	UNF5/8 ×18	29	37
FL-1412	PT1/2	12	24	UNF3/4 ×16	29	40
FL-1404	PT1/2	12.7	24	UNF3/4 ×16	29	40
FL-1415	PT1/2	15	27	UNF7/8 ×14	32	48
FL-1405	PT1/2	15.88	27	UNF7/8 ×14	32	48
FL-1615	PT3/4	15	27	UNF7/8 ×14	34	48
FL-1605	PT3/4	15.88	27	UNF7/8 ×14	34	48
FL-1606	PT3/4	19.05	32	UNS1 1/16 ×14	34	52

両口フレアーエルボ

C3604BD

C3771BD

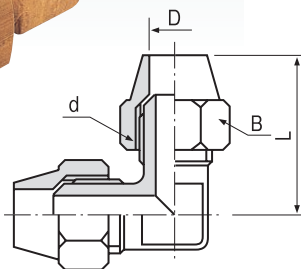

品番	適用管外径	寸法 (mm)		
	ϕD	B	d	L(約)
FL-2006	6	16	UNF7/16×20	29
FL-2022	6.35	16	UNF7/16×20	29
FL-2008	8	17	UNF1/2×20	29
FL-2033	9.53	21	UNF5/8×18	32
FL-2010	10	21	UNF5/8×18	32
FL-2012	12	24	UNF3/4×16	40
FL-2044	12.7	24	UNF3/4×16	40
FL-2015	15	27	UNF7/8×14	48
FL-2055	15.88	27	UNF7/8×14	48
FL-2066	19.05	32	UNS1 $\frac{1}{16}$ ×14	52

三方フレアーチーズ

C3604BD

C3771BD

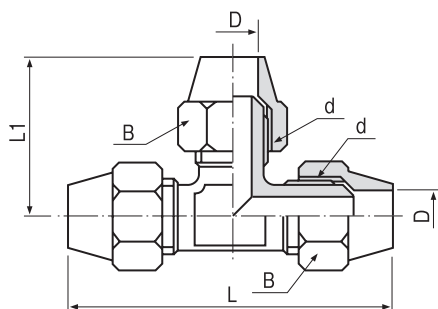

品番	適用管外径	寸法 (mm)			
	ϕD	B	d	L1(約)	L(約)
FT-3206	6	16	UNF7/16×20	29	58
FT-3202	6.35	16	UNF7/16×20	29	58
FT-3208	8	17	UNF1/2×20	29	58
FT-3303	9.53	21	UNF5/8×18	32	64
FT-3310	10	21	UNF5/8×18	32	64
FT-3412	12	24	UNF3/4×16	40	80
FT-3404	12.7	24	UNF3/4×16	40	80
FT-3515	15	27	UNF7/8×14	48	96
FT-3505	15.88	27	UNF7/8×14	48	96
FT-3606	19.05	32	UNS1 $\frac{1}{16}$ ×14	52	104

二方フレーサーチーズ

C3604BD

C3771BD

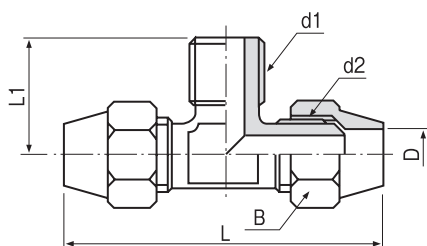
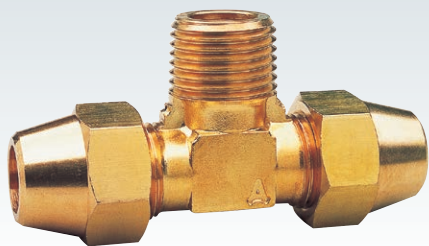

品番	取付ネジ	適用管外径 φD	寸法 (mm)			
	d1		B	d2	L1	L(約)
FT-2106	PT1/8	6	16	UNF7/16×20	19	58
FT-2102	PT1/8	6.35	16	UNF7/16×20	19	58
FT-2108	PT1/8	8	17	UNF1/2 ×20	19	58
FT-2206	PT1/4	6	16	UNF7/16×20	22	58
FT-2202	PT1/4	6.35	16	UNF7/16×20	22	58
FT-2208	PT1/4	8	17	UNF1/2 ×20	22	58
FT-2203	PT1/4	9.53	21	UNF5/8 ×18	24	64
FT-2210	PT1/4	10	21	UNF5/8 ×18	24	64
FT-2306	PT3/8	6	16	UNF7/16×20	25	64
FT-2302	PT3/8	6.35	16	UNF7/16×20	25	64
FT-2308	PT3/8	8	17	UNF1/2 ×20	25	64
FT-2303	PT3/8	9.53	21	UNF5/8 ×18	25	64
FT-2310	PT3/8	10	21	UNF5/8 ×18	25	64
FT-2312	PT3/8	12	24	UNF3/4 ×16	29	80
FT-2304	PT3/8	12.7	24	UNF3/4 ×16	29	80
FT-2403	PT1/2	9.53	21	UNF5/8 ×18	29	74
FT-2410	PT1/2	10	21	UNF5/8 ×18	29	74
FT-2412	PT1/2	12	24	UNF3/4 ×16	29	80
FT-2404	PT1/2	12.7	24	UNF3/4 ×16	29	80
FT-2415	PT1/2	15	27	UNF7/8 ×14	32	96
FT-2405	PT1/2	15.88	27	UNF7/8 ×14	32	96
FT-2606	PT3/4	19.05	32	UNS1 1/16 ×14	34	103

フレーサーナット

C3604BD

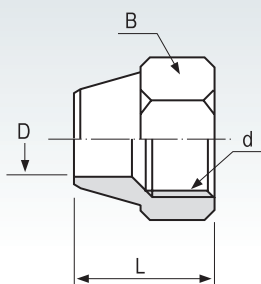

品番	適用管外径 φD	寸法 (mm)		
	d	B	L	
FN-1006	6	UNF7/16×20	16	17.5
*FN-1022	6.35	UNF7/16×20	16	17.5
FN-1008	8	UNF1/2 ×20	17	18
*FN-1033	9.53	UNF5/8 ×18	21	21
FN-1010	10	UNF5/8 ×18	21	21
FN-1012	12	UNF3/4 ×16	24	24
*FN-1044	12.7	UNF3/4 ×16	24	24
FN-1015	15	UNF7/8 ×14	27	28
*FN-1055	15.88	UNF7/8 ×14	27	28
FN-1066	19.05	UNS1 1/16 ×14	32	32

※は六角カドにVミゾ入

フレーサーキャップ

C3604BD

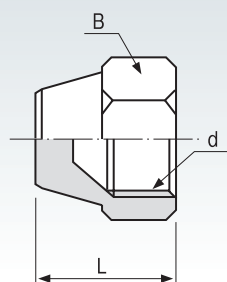
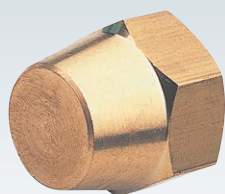

品番	寸法 (mm)		
	d	B	L
FN-0006	UNF7/16×20	16	17.5
FN-0008	UNF1/2 ×20	17	18
FN-0010	UNF5/8 ×18	21	21
FN-0012	UNF3/4 ×16	24	24
FN-0015	UNF7/8 ×14	27	28
FN-0066	UNS1 1/16 ×14	32	32

四角プラグ

C3604BD

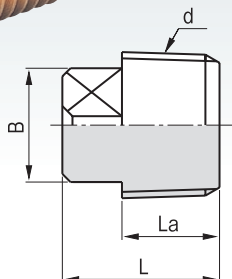
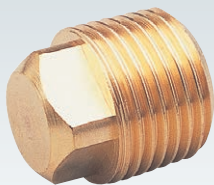

品番	RoHS品番	取付ネジ	寸法 (mm)		
		d	B	La	L
NP-1001	NP-1001R	PT1/8	7	9	15
NP-1002	NP-1002R	PT1/4	9	11	19
NP-1003	NP-1003R	PT3/8	12	13	21
NP-1004	NP-1004R	PT1/2	14	15	23
NP-1006	NP-1006R	PT3/4	17	18	29

六角プラグ

C3604BD

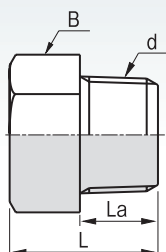
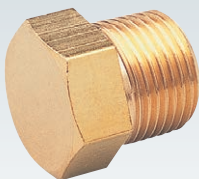

品番	RoHS品番	取付ネジ	寸法 (mm)		
		d	B	La	L
HP-1001	HP-1001R	PT1/8	12	9	14
HP-1002	HP-1002R	PT1/4	16	12	18
HP-1003	HP-1003R	PT3/8	19	13	21
HP-1004	HP-1004R	PT1/2	21	16	25

六角キャップ

C3604BD

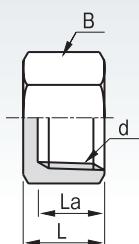

品番	RoHS品番	取付ネジ	寸法 (mm)		
		d	B	La	L
NC-1001	NC-1001R	PT1/8	12	7.5	9
NC-1002	NC-1002R	PT1/4	16	9.5	11
NC-1003	NC-1003R	PT3/8	19	12	14
NC-1004	NC-1004R	PT1/2	24	13	15
NC-1006	NC-1006R	PT3/4	30	15	18

六角ニップル

C3604BD

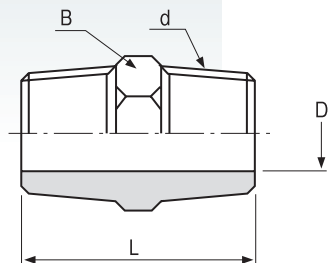
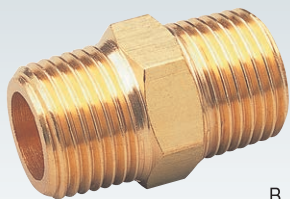

品番	RoHS 品番	取付ネジ	寸法 (mm)		
		d	ϕD	B	L
NT-1011	NT-1011R	PT1/8	5	12	22
NT-1022	NT-1022R	PT1/4	8	14	28
NT-1033	NT-1033R	PT3/8	11	17	33
NT-1044	NT-1044R	PT1/2	13	22	38
NT-1066	NT-1066R	PT3/4	18	27	46
NT-1088	NT-1088R	PT 1	24	35	53

異径六角ニップル

C3604BD

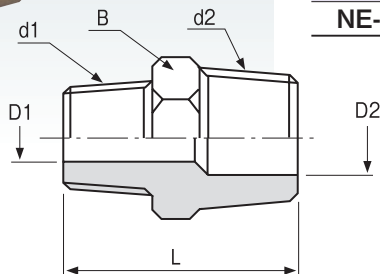
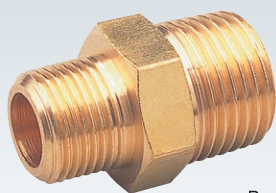

品番	RoHS 品番	取付ネジ		寸法 (mm)			
		d1	d2	$\phi D1$	$\phi D2$	B	L
NE-1012	NE-1012R	PT1/8	PT1/4	5	8	14	26
NE-1013	NE-1013R	PT1/8	PT3/8	5	11	17	29
NE-1023	NE-1023R	PT1/4	PT3/8	8	11	17	31
NE-1024	NE-1024R	PT1/4	PT1/2	8	13	22	34
NE-1034	NE-1034R	PT3/8	PT1/2	11	13	22	36
NE-1036	NE-1036R	PT3/8	PT3/4	11	18	27	41
NE-1046	NE-1046R	PT1/2	PT3/4	13	18	27	43
NE-1048	NE-1048R	PT1/2	PT 1	13	24	35	47
NE-1068	NE-1068R	PT3/4	PT 1	18	24	35	50

丸ニップル

C3604BD

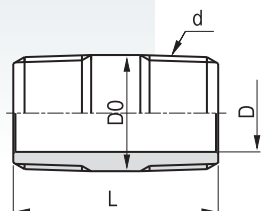
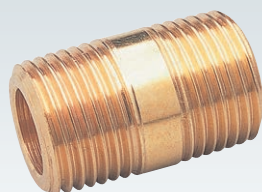

品番	RoHS 品番	取付ネジ	寸法 (mm)		
		d	ϕD	$\phi D0$	L
NI-1011	NI-1011R	PT1/8	6	10	22
NI-1022	NI-1022R	PT1/4	9	14	27
NI-1033	NI-1033R	PT3/8	11	17	31
NI-1044	NI-1044R	PT1/2	13	21	34
NI-1066	NI-1066R	PT3/4	18	27	40
NI-1088	NI-1088R	PT 1	24	34	44

ブッシング

C3604BD

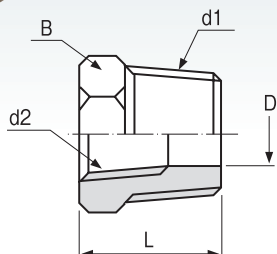

品番	RoHS品番	取付ネジ		寸法 (mm)		
		d1	d2	φD	B	L
NB-1021	NB-1021R	PT1/4	PT1/8	8.2	17	16
NB-1031	NB-1031R	PT3/8	PT1/8	8.2	19	19
NB-1032	NB-1032R	PT3/8	PT1/4	11	19	19
NB-1041	NB-1041R	PT1/2	PT1/8	8.2	24	21
NB-1042	NB-1042R	PT1/2	PT1/4	11	24	21
NB-1043	NB-1043R	PT1/2	PT3/8	14.5	24	21
NB-1062	NB-1062R	PT3/4	PT1/4	11	30	25
NB-1063	NB-1063R	PT3/4	PT3/8	14.5	30	25
NB-1064	NB-1064R	PT3/4	PT1/2	18	30	25
NB-1083	NB-1083R	PT 1	PT3/8	14.5	35	32
NB-1084	NB-1084R	PT 1	PT1/2	18	35	32
NB-1086	NB-1086R	PT 1	PT3/4	23	35	32

六角ソケット

C3604BD

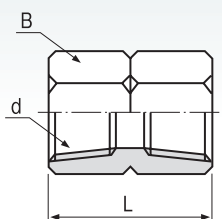
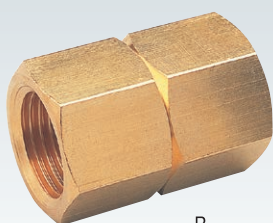

品番	RoHS品番	取付ネジ	寸法 (mm)	
		d	B	L
NS-1011	NS-1011R	PT1/8	14	21
NS-1022	NS-1022R	PT1/4	17	28
NS-1033	NS-1033R	PT3/8	21	32
NS-1044	NS-1044R	PT1/2	26	40
NS-1066	NS-1066R	PT3/4	32	49

異径六角ソケット

C3604BD

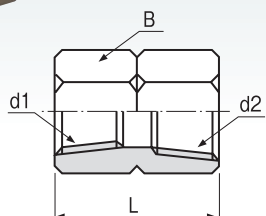
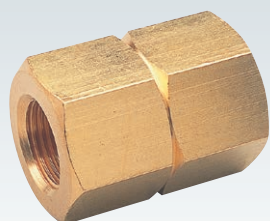

品番	RoHS品番	取付ネジ		寸法 (mm)	
		d1	d2	B	L
NS-1012	NS-1012R	PT1/8	PT1/4	17	26
NS-1013	NS-1013R	PT1/8	PT3/8	21	28
NS-1023	NS-1023R	PT1/4	PT3/8	21	30
NS-1024	NS-1024R	PT1/4	PT1/2	26	36
NS-1034	NS-1034R	PT3/8	PT1/2	26	38
NS-1036	NS-1036R	PT3/8	PT3/4	32	44
NS-1046	NS-1046R	PT1/2	PT3/4	32	46

内・外ソケット

C3604BD

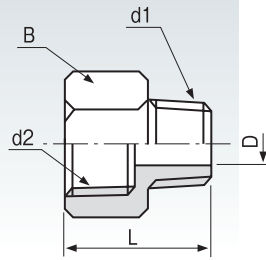
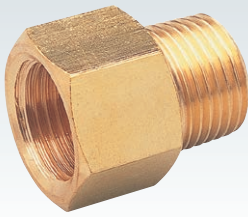

品番	RoHS 品番	取付ネジ		寸法 (mm)		
		d1	d2	φD	B	L
NF-1011	NF-1011R	PT1/8	PT1/8	5	14	20
NF-1022	NF-1022R	PT1/4	PT1/4	8	17	24
NF-1033	NF-1033R	PT3/8	PT3/8	11	21	28
NF-1044	NF-1044R	PT1/2	PT1/2	13	26	33
NF-1066	NF-1066R	PT3/4	PT3/4	18	32	39

異径内・外ソケット

C3604BD

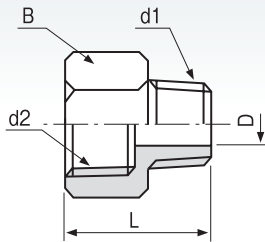

品番	RoHS 品番	取付ネジ		寸法 (mm)		
		d1	d2	φD	B	L
NF-1012	NF-1012R	PT1/8	PT1/4	5	17	22
NF-1013	NF-1013R	PT1/8	PT3/8	5	21	24
NF-1021	NF-1021R	PT1/4	PT1/8	5	14	22
NF-1023	NF-1023R	PT1/4	PT3/8	8	21	26
NF-1024	NF-1024R	PT1/4	PT1/2	8	26	29
NF-1031	NF-1031R	PT3/8	PT1/8	5	17	24
NF-1032	NF-1032R	PT3/8	PT1/4	8	17	26
NF-1034	NF-1034R	PT3/8	PT1/2	11	26	31
NF-1036	NF-1036R	PT3/8	PT3/4	11	32	34
NF-1042	NF-1042R	PT1/2	PT1/4	8	22	28
NF-1043	NF-1043R	PT1/2	PT3/8	11	22	30
NF-1046	NF-1046R	PT1/2	PT3/4	13	32	36
NF-1063	NF-1063R	PT3/4	PT3/8	11	28	31
NF-1064	NF-1064R	PT3/4	PT1/2	13	28	36

変換内・外ソケット

C3604BD

(NF-3000)

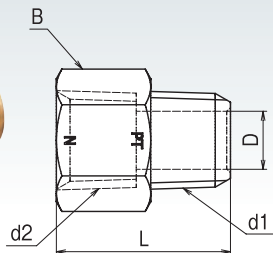

RoHS 品番	取付ネジ		寸法 (mm)		
	d1	d2	φD	B	L
NF-3011	PT1/8	NPT1/8	5	14	20
NF-3022	PT1/4	NPT1/4	8	17	24
NF-3033	PT3/8	NPT3/8	11	21	28
NF-3044	PT1/2	NPT1/2	13	26	33
NF-3066	PT3/4	NPT3/4	18	32	39
NF-3088	PT 1	NPT 1	24	40	48
NF-3111	NPT1/8	PT1/8	5	14	20
NF-3122	NPT1/4	PT1/4	8	17	24
NF-3133	NPT3/8	PT3/8	11	21	28
NF-3144	NPT1/2	PT1/2	13	26	33
NF-3166	NPT3/4	PT3/4	18	32	39
NF-3188	NPT 1	PT 1	24	40	48
NF-3281	UNF1/4-28	PT1/8	2.5	12	20
NF-3611	M6×P1.0	PT1/8	2.5	12	20

(NF-3100)

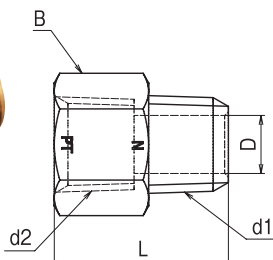

(NF-3281, NF-3611)

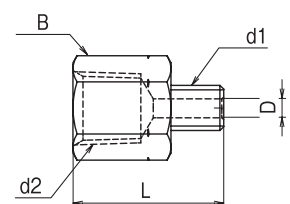

内ネジエルボ

C3771BD

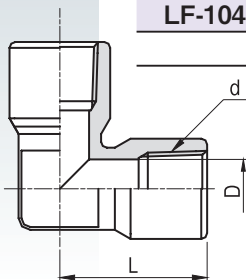

品番	RoHS品番	取付ネジ	寸法 (mm)	
		d	φD	L
LF-1011	LF-1011R	PT1/8	4	22
LF-1022	LF-1022R	PT1/4	8	25
LF-1033	LF-1033R	PT3/8	10	29
LF-1044	LF-1044R	PT1/2	13	34
	LF-1066R	PT3/4	19	48

異径内ネジエルボ

C3771BD

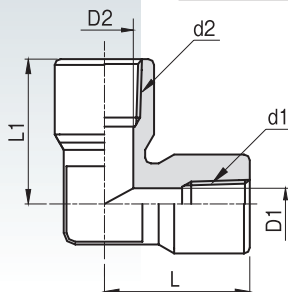

RoHS品番	取付ネジ		寸法 (mm)			
	d1	d2	φD1	φD2	L1	L
LF-1012	PT1/8	PT1/4	4	8	25	25
LF-1023	PT1/4	PT3/8	8	10	29	29
LF-1034	PT3/8	PT1/2	10	13	34	34

内・外エルボ

C3771BD

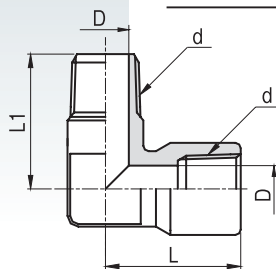

品番	RoHS品番	取付ネジ	寸法 (mm)		
		d	φD	L1	L
LK-1011	LK-1011R	PT1/8	4	19	22
LK-1022	LK-1022R	PT1/4	8	24	25
LK-1033	LK-1033R	PT3/8	10	28	29
LK-1044	LK-1044R	PT1/2	13	32	34
	LK-1066R	PT3/4	19	47	48

異径内・外エルボ

C3771BD

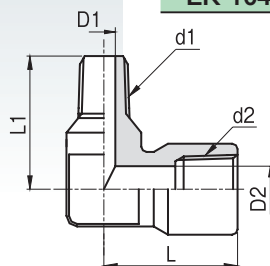

RoHS品番	取付ネジ		寸法 (mm)			
	d1	d2	φD1	φD2	L1	L
LK-1012	PT1/8	PT1/4	4	8	21	25
LK-1021	PT1/4	PT1/8	8	4	22	22
LK-1023	PT1/4	PT3/8	8	10	29	29
LK-1032	PT3/8	PT1/4	10	8	25	25
LK-1034	PT3/8	PT1/2	10	13	34	34
LK-1043	PT1/2	PT3/8	13	10	29	29

内ネジチーズ

C3771BD

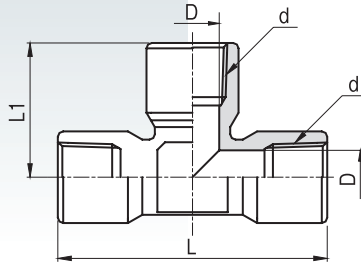

品番	RoHS品番	取付ネジ	寸法 (mm)		
		d	φD	L1	L
TF-1111	TF-1111R	PT1/8	4	22	44
TF-1222	TF-1222R	PT1/4	8	25	50
TF-1333	TF-1333R	PT3/8	10	29	58
TF-1444	TF-1444R	PT1/2	13	34	68

異径内ネジチーズ

C3771BD

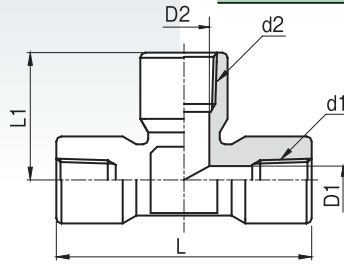

RoHS品番	取付ネジ		寸法 (mm)			
	d1	d2	φD1	φD2	L1	L
TF-1112	PT1/8	PT1/4	4	8	25	50
TF-1221	PT1/4	PT1/8	8	4	25	50
TF-1223	PT1/4	PT3/8	8	10	29	58
TF-1332	PT3/8	PT1/4	10	8	29	58
TF-1334	PT3/8	PT1/2	10	13	34	68
TF-1443	PT1/2	PT3/8	13	10	34	68

二方チーズ

C3771BD

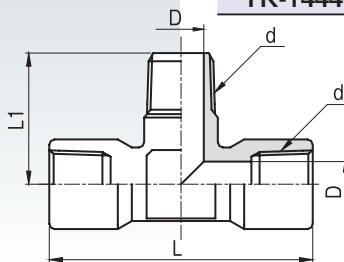

品番	RoHS相当品番	取付ネジ	寸法 (mm)		
		d	φD	L1	L
TK-1111	TK-1111R	PT1/8	4	19	44
TK-1222	TK-1222R	PT1/4	8	24	50
TK-1333	TK-1333R	PT3/8	10	28	58
TK-1444	TK-1444R	PT1/2	13	32	68

異径二方チーズ

C3771BD

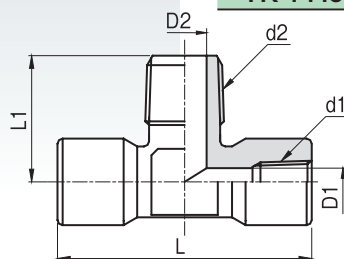

RoHS品番	取付ネジ		寸法 (mm)			
	d1	d2	φD1	φD2	L1	L
TK-1112	PT1/8	PT1/4	4	8	22	44
TK-1221	PT1/4	PT1/8	8	4	25	50
TK-1223	PT1/4	PT3/8	8	10	25	50
TK-1332	PT3/8	PT1/4	10	8	29	58
TK-1334	PT3/8	PT1/2	10	13	29	58
TK-1443	PT1/2	PT3/8	13	10	34	68

外ネジエルボ

C3771BD

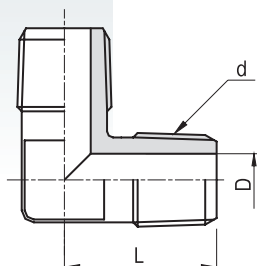

品番	RoHS品番	取付ネジ	寸法 (mm)	
		d	φD	L
LM-1011	LM-1011R	PT1/8	4	17
LM-1022	LM-1022R	PT1/4	8	22
LM-1033	LM-1033R	PT3/8	10	25
LM-1044	LM-1044R	PT1/2	13	29
LM-1066	LM-1066R	PT3/4	17	34

外ネジチーズ

C3771BD

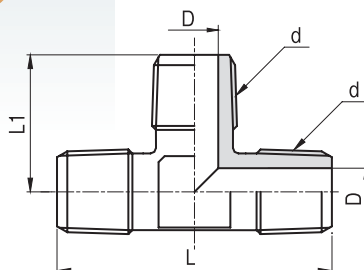

品番	RoHS品番	取付ネジ	寸法 (mm)		
		d	φD	L1	L
TM-1111	TM-1111R	PT1/8	4	17	34
TM-1222	TM-1222R	PT1/4	8	22	44
TM-1333	TM-1333R	PT3/8	10	25	50
TM-1444	TM-1444R	PT1/2	13	29	58
TM-1666	TM-1666R	PT3/4	17	34	68

クロス

C3771BD

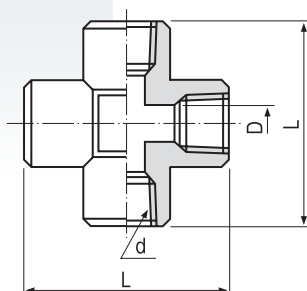

RoHS品番	取付ネジ	寸法 (mm)	
	d	φD	L
KK-1111	PT1/8	8	33
KK-1222	PT1/4	10	38
KK-1333	PT3/8	13	45

変換内・外ソケット

SUS304

(NF-8300)

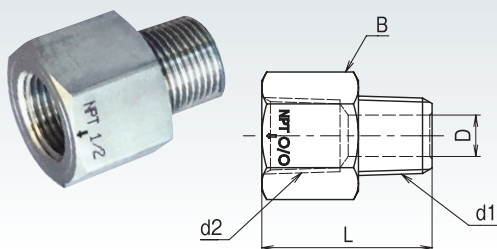

(NF-8400)

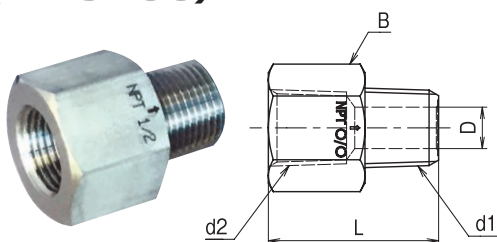

(NF-8281, NF-8611)

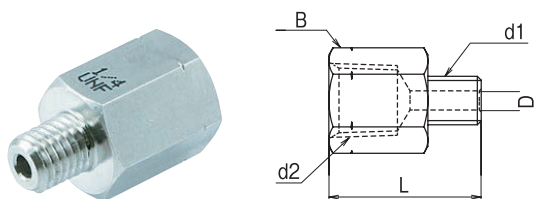

品番	取付ネジ		寸法 (mm)		
	d1	d2	φD	B (HEX)	L
NF-8311	PT1/8	NPT1/8	4	17	27
NF-8322	PT1/4	NPT1/4	7	22	35
NF-8333	PT3/8	NPT3/8	9	24	37
NF-8344	PT1/2	NPT1/2	13	32	46
NF-8366	PT3/4	NPT3/4	16	36	50
NF-8388	PT 1	NPT 1	20	46	60
NF-8411	NPT1/8	PT1/8	4	17	27
NF-8422	NPT1/4	PT1/4	7	22	35
NF-8433	NPT3/8	PT3/8	9	24	37
NF-8444	NPT1/2	PT1/2	13	32	46
NF-8466	NPT3/4	PT3/4	16	36	50
NF-8488	NPT 1	PT 1	20	46	60
NF-8281	UNF1/4-28	PT1/8	2.5	12	20
NF-8611	M6×P1.0	PT1/8	2.5	12	20

※NF-8300、NF-8400は使用圧力20.6MPa以下(使用条件によっては変動が生じます。)

フレキ用ニップル

SUS304

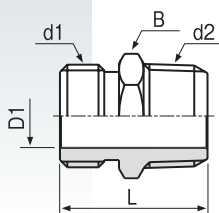

品番	寸法 (mm)				
	d1	d2	φD1	B	L
PN-7044	PF1/2	PT1/2	13	22	30
PN-7066	PF3/4	PT3/4	18	27	34

フレキチューブ用袋ナット

SUS304

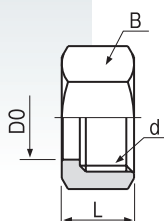
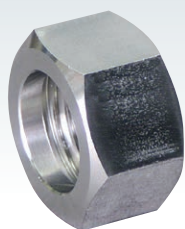

品番	寸法 (mm)			
	d	φD0	B	L
PH-7N04	PF1/2	16.3	24	14
PH-7N06	PF3/4	20.4	30	15

ASOH アソー株式会社

本社 〒544-0004 大阪市生野区巽北4丁目14番21号
TEL.(06)6755-3301(代) FAX.(06)6755-3808

トキョーオフィス 〒101-0031 東京都千代田区東神田2丁目7番1号
広部ミヤケビル二階
TEL.(03)5835-3115(代) FAX.(03)5835-3116

イタチポリセンター 〒550-0013 大阪市西区新町3丁目9番1号
TEL.(06)6538-3101(代) FAX.(06)6538-3103

URL <http://www.asoh.co.jp> E-mail info@asoh.co.jp