

断面図 A-A

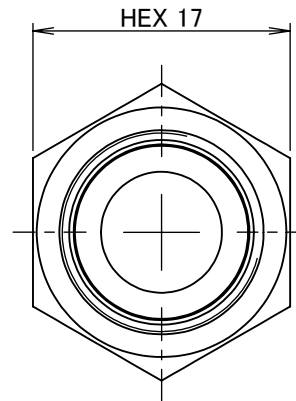
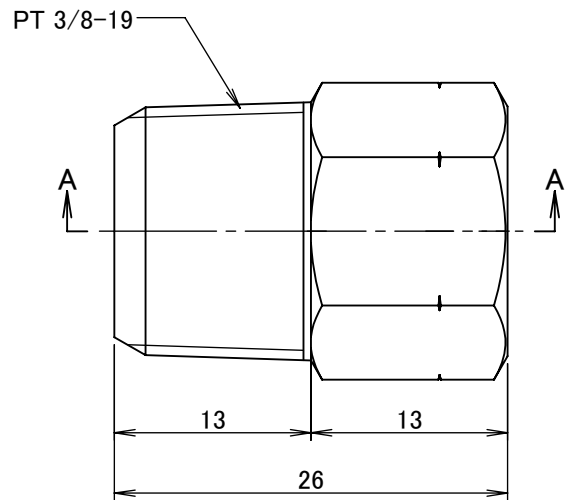
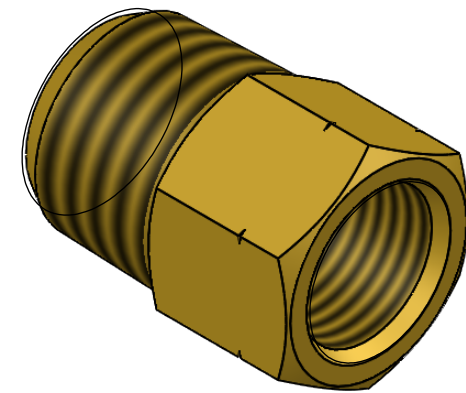

		第3角法	単位 mm	尺度 2:1	日付 2020/12/09
承認	水田	検図	水田	材質	C3604BD(cd75ppm以下)
設計	水田	製図	恵良	備考	
			品名		異径内・外ソケット NF-1032R
			図番		5R-NF1032
ASOH CO.,LTD.					