

断面図 A-A

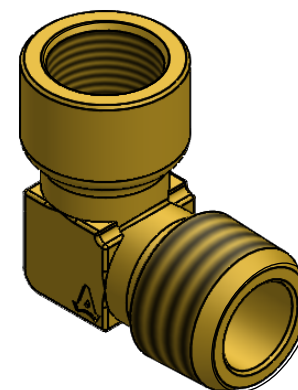
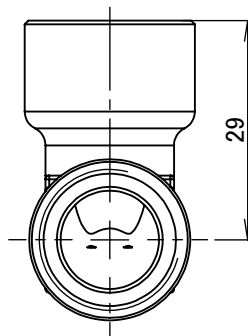
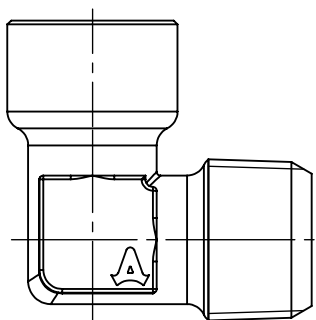

		第3角法		単位 mm	尺度 1:1	日付 2020/12/11
承認	水田	検図	水田	材質 C3771B(cd75ppm以下)		
設計	水田	製図	恵良	備考		
				品名 異径内・外エルボ LK-1043R		
				図番 5R-LK1043		
ASOH CO.,LTD.						