

断面図 A-A

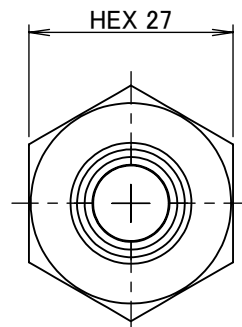
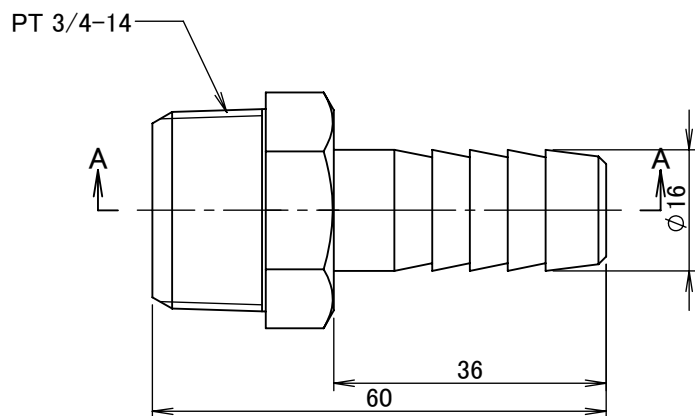
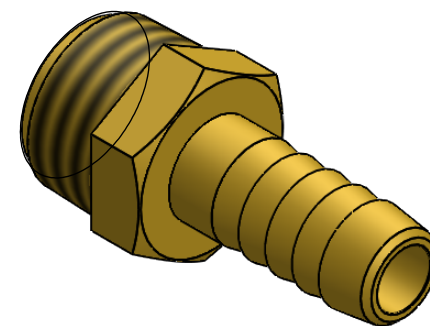

		第3角法	単位 mm	尺度 1:1	日付 2021/03/22
承認	水田	検図	水田	材質 C3604BD(cd75ppm以下)	
設計	水田	製図	恵良	備考	
				品名 ホースニップル HN-1616R	
				図番 5R-HN1616	
ASOH CO.,LTD.					