

断面図 A-A

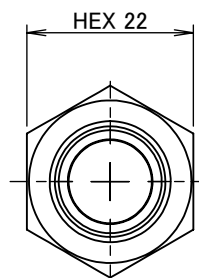
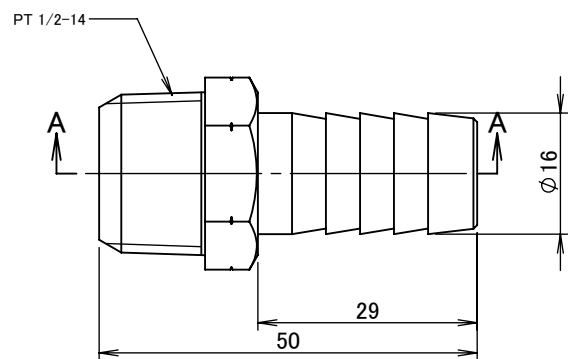
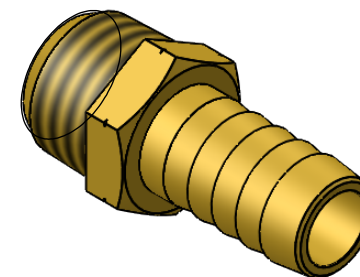

		第3角法	単位 mm	尺度 1:1	日付 2021/03/22
承認 水田	検図 水田	材質	C3604BD(cd75ppm以下)		
設計 水田	製図 水田	備考			
ASOH Valve & Fitting Brand ASOH CO.,LTD.		品名	ホースニップル HN-1416R		
		図番	5R-HN1416		